

# RIPPLE PAN #10D

Section

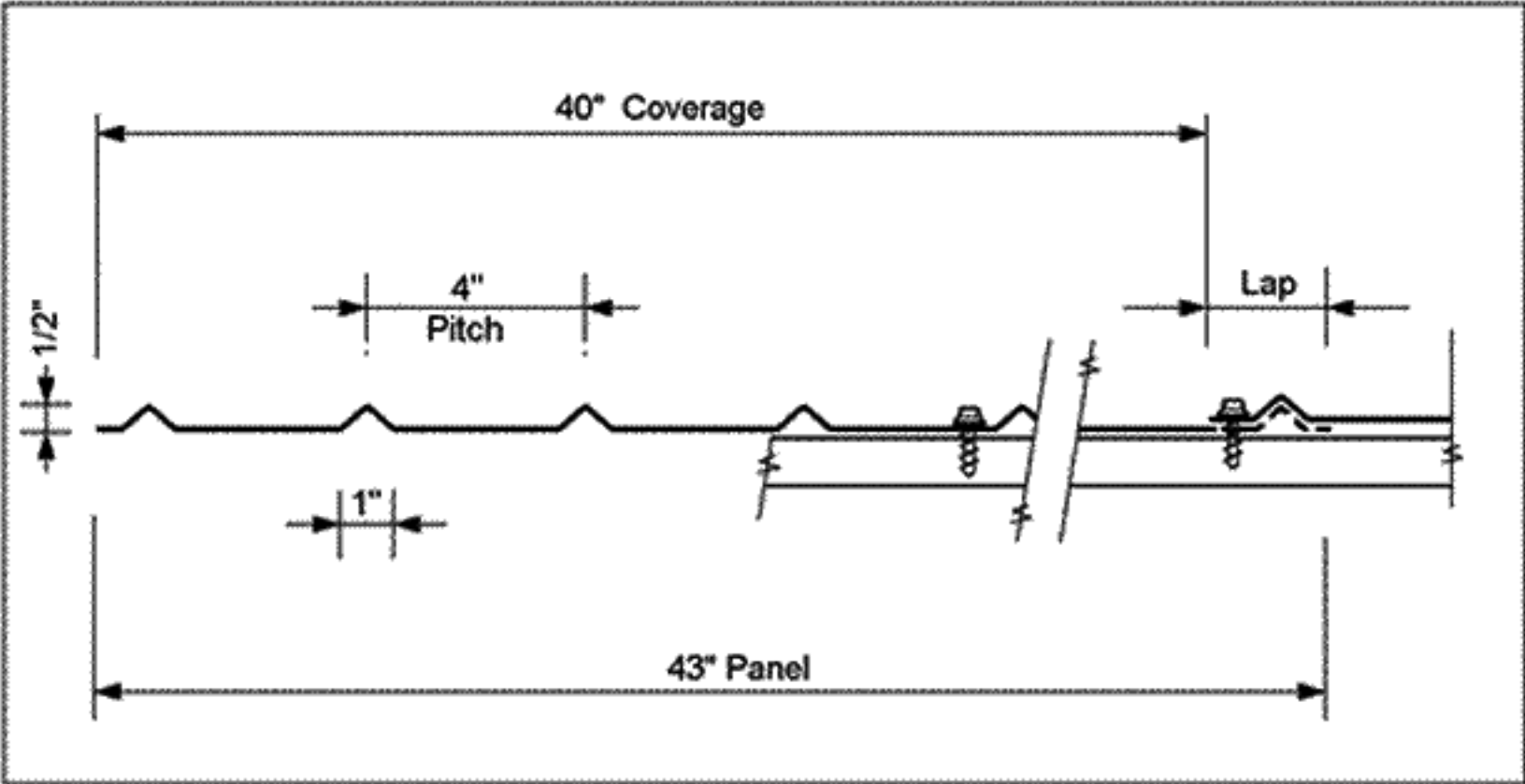

Panel Data

MODEL NO.	THICK.	METAL	#/SF
<input type="checkbox"/> RP10D20A	0.020"	Aluminum	0.33#
<input type="checkbox"/> RP10D25A	0.025"	Aluminum	0.42#
<input type="checkbox"/> RP10D32A	0.032"	Aluminum	0.53#
<input type="checkbox"/> RP10D40A	0.040"	Aluminum	0.66#
<input type="checkbox"/> RP10D50A	0.050"	Aluminum	0.83#
<input type="checkbox"/> RP10D18G	26 GA. (.018")	Galvanized	0.86#
<input type="checkbox"/> RP10D24G	24 GA. (.024")	Galvanized	1.15#
<input type="checkbox"/> RP10D30G	22 GA. (.030")	Galvanized	1.44#

Technical

**FINISH:** Standard are White (F41), Baron Ivory (F105), and Victorian Gray (F307)  
 Custom are electro statically applied poly-urethane epoxy paint (F47)  
 Premium are Satin Anodized (F23R), Brushed (F98), and Stainless (F08)  
 Kynar: 32 in stock colors

**FIRE CODE:** Metal is non-combustible (ASTM E-84)

**PERF PATTERN:** Standard perf is "P8" = 1/8" diam. by 21/64" staggs  
 Other patterns available upon request

**PANEL LENGTH:** Standard length this profile is 10'-0"  
 Other lengths available upon request from 2' to 10'



# RIPPLE PAN #20D

## Section

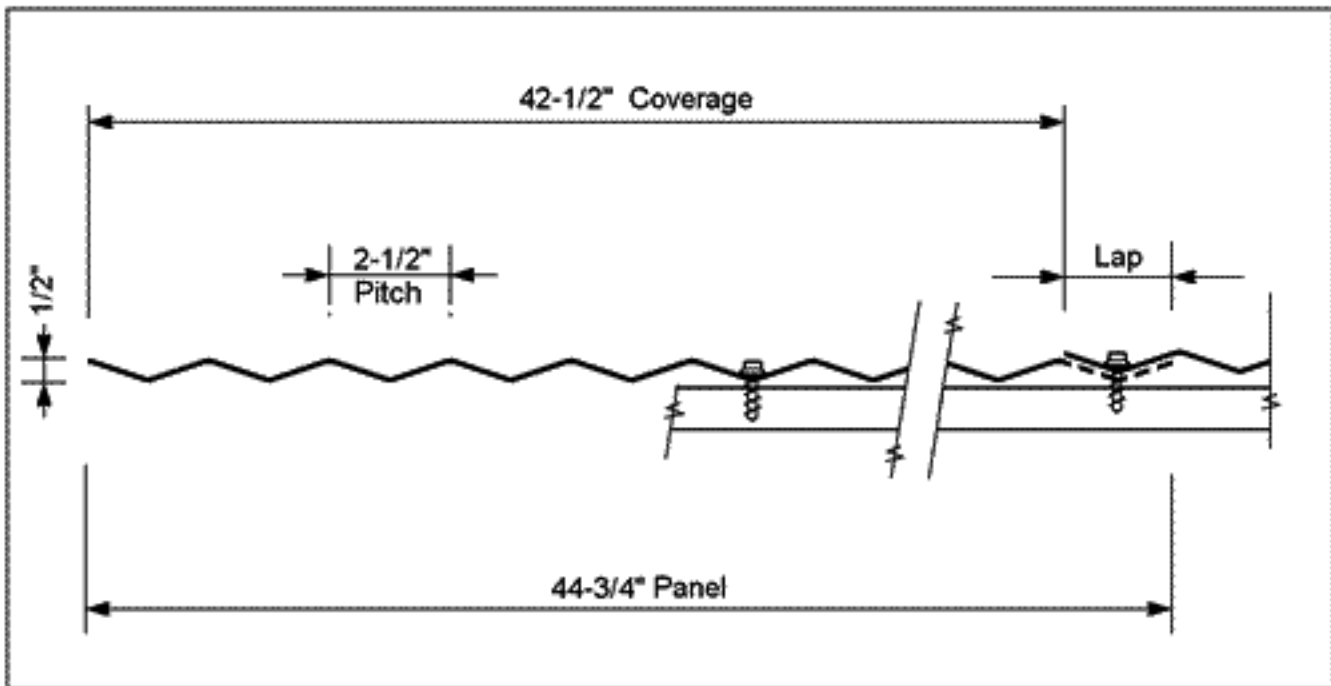

## Panel Data

MODEL NO.	THICK.	METAL	#/SF
<input type="checkbox"/> RP20D20A	0.020"	Aluminum	0.33#
<input type="checkbox"/> RP20D25A	0.025"	Aluminum	0.42#
<input type="checkbox"/> RP20D32A	0.032"	Aluminum	0.53#
<input type="checkbox"/> RP20D40A	0.040"	Aluminum	0.66#
<input type="checkbox"/> RP20D50A	0.050"	Aluminum	0.83#
<input type="checkbox"/> RP20D18G	26 GA. (.018")	Galvanized	0.86#
<input type="checkbox"/> RP20D24G	24 GA. (.024")	Galvanized	1.15#
<input type="checkbox"/> RP20D30G	22 GA. (.030")	Galvanized	1.44#

## Technical

**FINISH:** Standard are White (F41), Baron Ivory (F105), and Victorian Gray (F307)  
 Custom are electro statically applied poly-urethane epoxy paint (F47)  
 Premium are Satin Anodized (F23R), Brushed (F98), and Stainless (F08)  
 Kynar: 32 in stock colors

**FIRE CODE:** Metal is non-combustible (ASTM E-84)

**PERF PATTERN:** Standard perf is "P8" = 1/8" diam. by 21/64" staggs  
 Other patterns available upon request

**PANEL LENGTH:** Standard length this profile is 10'-0"  
 Other lengths available upon request from 2' to 10'



**AMERICAN DECORATIVE CEILINGS**

(All Rights Reserved) ©2020.ADC

Mail: Post Office Box 605605 - Cleveland, Ohio 44105  
 Packages: 4510 East 71st St. - Cleveland, Ohio 44105  
 Telephone: (216) 341-2222  
 FAX: (216) 341-8501

# RIPPLE PAN #26D

## Section

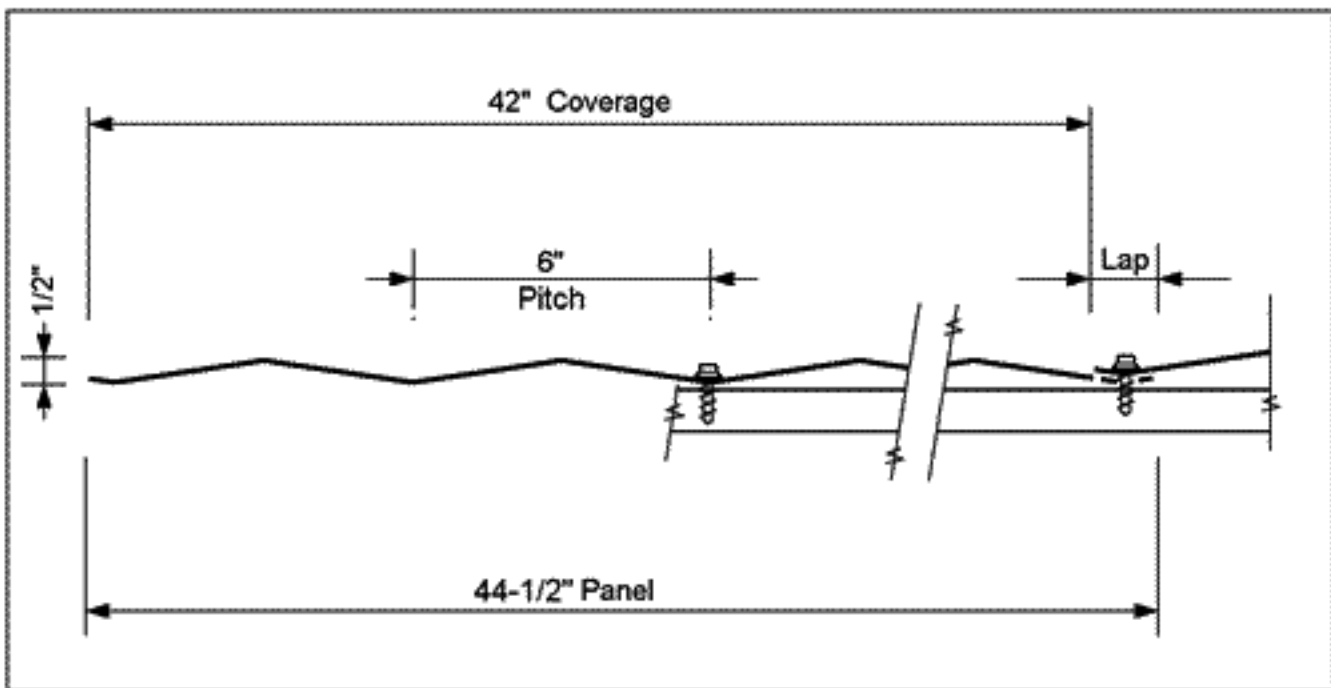

## Panel Data

MODEL NO.	THICK.	METAL	#/SF
<input type="checkbox"/> RP26D20A	0.020"	Aluminum	0.33#
<input type="checkbox"/> RP26D25A	0.025"	Aluminum	0.42#
<input type="checkbox"/> RP26D32A	0.032"	Aluminum	0.53#
<input type="checkbox"/> RP26D40A	0.040"	Aluminum	0.66#
<input type="checkbox"/> RP26D50A	0.050"	Aluminum	0.83#
<input type="checkbox"/> RP26D18G	26 GA. (.018")	Galvanized	0.86#
<input type="checkbox"/> RP26D24G	24 GA. (.024")	Galvanized	1.15#
<input type="checkbox"/> RP26D30G	22 GA. (.030")	Galvanized	1.44#

## Technical

**FINISH:** Standard are White (F41), Baron Ivory (F105), and Victorian Gray (F307)  
 Custom are electro statically applied poly-urethane epoxy paint (F47)  
 Premium are Satin Anodized (F23R), Brushed (F98), and Stainless (F08)  
 Kynar: 32 in stock colors

**FIRE CODE:** Metal is non-combustible (ASTM E-84)

**PERF PATTERN:** Standard perf is "P8" = 1/8" diam. by 21/64" staggs  
 Other patterns available upon request

**PANEL LENGTH:** Standard length this profile is 10'-0"  
 Other lengths available upon request from 2' to 10'



**AMERICAN DECORATIVE CEILINGS**

(All Rights Reserved) ©2000

Mail: Post Office Box 605605 - Cleveland, Ohio 44105  
 Packages: 4510 East 71st St. - Cleveland, Ohio 44105  
 Telephone: (216) 341-2222  
 FAX: (216) 341-8501

# RIPPLE PAN #30R

## Section

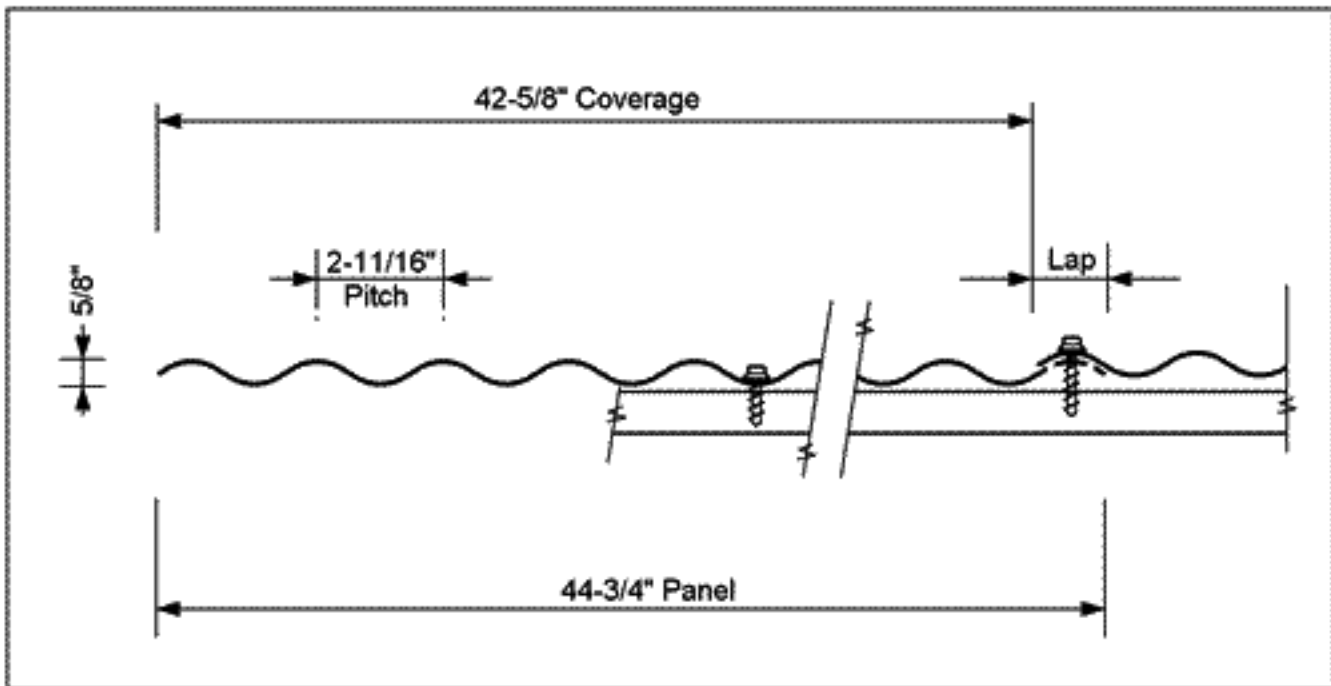

## Panel Data

MODEL NO.	THICK.	METAL	#/SF
<input type="checkbox"/> RP30R20A	0.020"	Aluminum	0.33#
<input type="checkbox"/> RP30R25A	0.025"	Aluminum	0.42#
<input type="checkbox"/> RP30R32A	0.032"	Aluminum	0.53#
<input type="checkbox"/> RP30R40A	0.040"	Aluminum	0.66#
<input type="checkbox"/> RP30R50A	0.050"	Aluminum	0.83#
<input type="checkbox"/> RP30R18G	26 GA. (.018")	Galvanized	0.86#
<input type="checkbox"/> RP30R24G	24 GA. (.024")	Galvanized	1.15#
<input type="checkbox"/> RP30R30G	22 GA. (.030")	Galvanized	1.44#

## Technical

**FINISH:** Standard are White (F41), Baron Ivory (F105), and Victorian Gray (F307)  
 Custom are electro statically applied poly-urethane epoxy paint (F47)  
 Premium are Satin Anodized (F23R), Brushed (F98), and Stainless (F08)  
 Kynar: 32 in stock colors

**FIRE CODE:** Metal is non-combustible (ASTM E-84)

**PERF PATTERN:** Standard perf is "P8" = 1/8" diam. by 21/64" staggs  
 Other patterns available upon request

**PANEL LENGTH:** Standard length this profile is 12'-0"  
 Other lengths available upon request from 4' to 40'



**AMERICAN DECORATIVE CEILINGS**

(All Rights Reserved) © 2000/01

Mail: Post Office Box 605605 - Cleveland, Ohio 44105  
 Packages: 4510 East 71st St. - Cleveland, Ohio 44105  
 Telephone: (216) 341-2222  
 FAX: (216) 341-8501

R-7

# RIPPLE PAN #31R

## Section

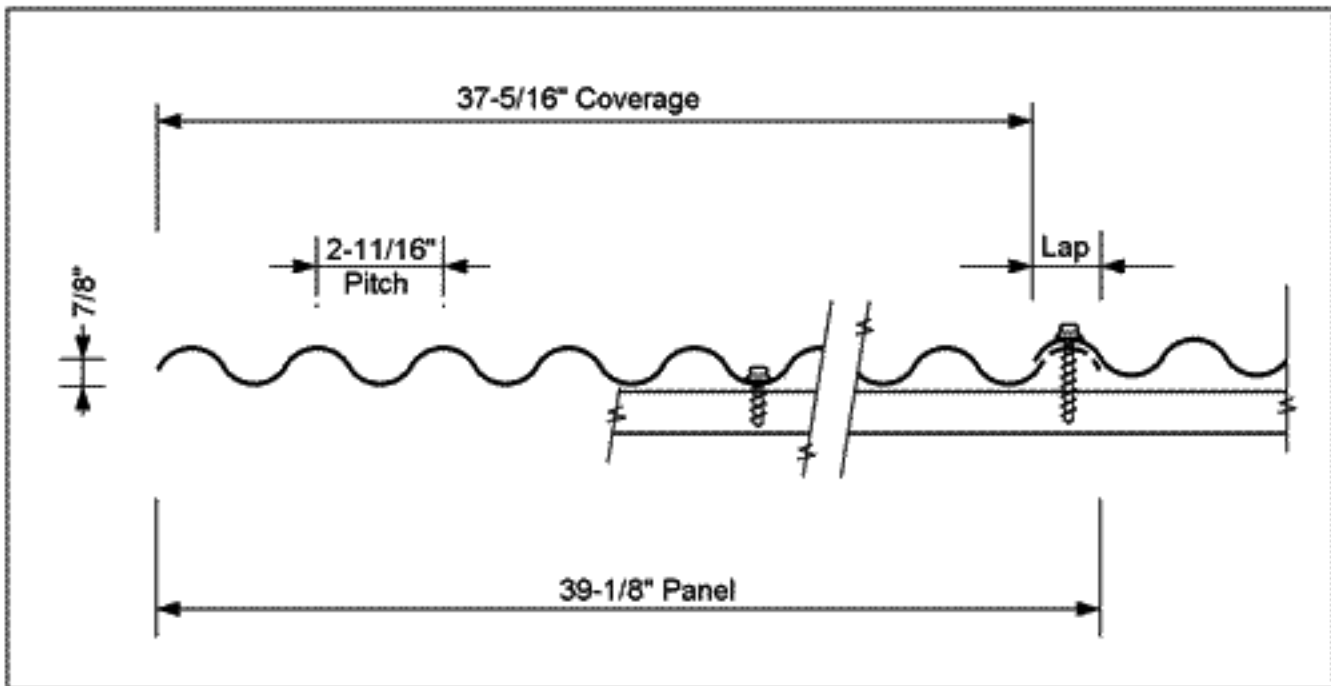

## Panel Data

MODEL NO.	THICK.	METAL	#/SF
<input type="checkbox"/> RP31R20A	0.020"	Aluminum	0.33#
<input type="checkbox"/> RP31R25A	0.025"	Aluminum	0.42#
<input type="checkbox"/> RP31R32A	0.032"	Aluminum	0.53#
<input type="checkbox"/> RP31R40A	0.040"	Aluminum	0.66#
<input type="checkbox"/> RP31R50A	0.050"	Aluminum	0.83#
<input type="checkbox"/> RP31R18G	26 GA. (.018")	Galvanized	0.86#
<input type="checkbox"/> RP31R24G	24 GA. (.024")	Galvanized	1.15#
<input type="checkbox"/> RP31R30G	22 GA. (.030")	Galvanized	1.44#

## Technical

**FINISH:** Standard are White (F41), Baron Ivory (F105), and Victorian Gray (F307)  
 Custom are electro statically applied poly-urethane epoxy paint (F47)  
 Premium are Satin Anodized (F23R), Brushed (F98), and Stainless (F08)  
 Kynar: 32 in stock colors

**FIRE CODE:** Metal is non-combustible (ASTM E-84)

**PERF PATTERN:** Standard perf is "P8" = 1/8" diam. by 21/64" staggs  
 Other patterns available upon request

**PANEL LENGTH:** Standard length this profile is 12'-0"  
 Other lengths available upon request from 4' to 40'



**AMERICAN DECORATIVE CEILINGS**

(All Rights Reserved) ©1991-2008

Mail: Post Office Box 605605 - Cleveland, Ohio 44105  
 Packages: 4510 East 71st St. - Cleveland, Ohio 44105  
 Telephone: (216) 341-2222  
 FAX: (216) 341-8501

# RIPPLE PAN #32R

## Section

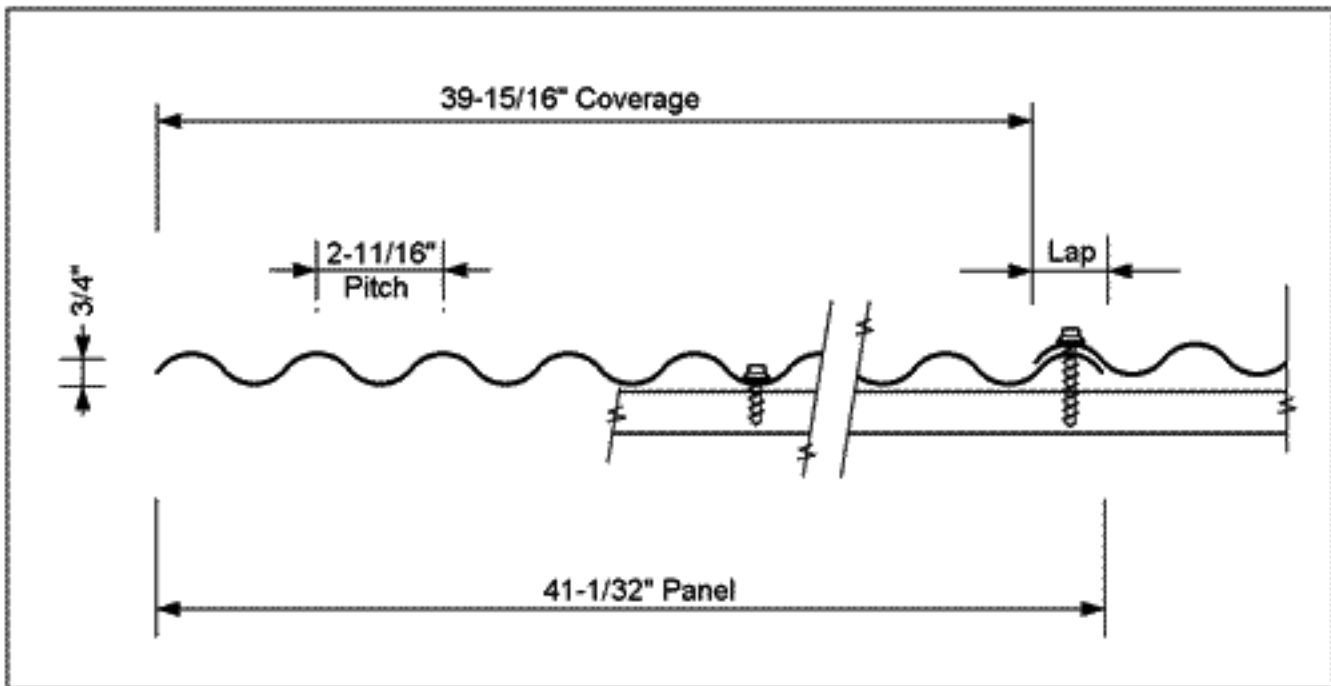

## Panel Data

MODEL NO.	THICK.	METAL	#/SF
<input type="checkbox"/> RP32R20A	0.020"	Aluminum	0.33#
<input type="checkbox"/> RP32R25A	0.025"	Aluminum	0.42#
<input type="checkbox"/> RP32R32A	0.032"	Aluminum	0.53#
<input type="checkbox"/> RP32R40A	0.040"	Aluminum	0.66#
<input type="checkbox"/> RP32R50A	0.050"	Aluminum	0.83#
<input type="checkbox"/> RP32R18G	26 GA. (.018")	Galvanized	0.86#
<input type="checkbox"/> RP32R24G	24 GA. (.024")	Galvanized	1.15#
<input type="checkbox"/> RP32R30G	22 GA. (.030")	Galvanized	1.44#

## Technical

**FINISH:** Standard are White (F41), Baron Ivory (F105), and Victorian Gray (F307)  
 Custom are electro statically applied poly-urethane epoxy paint (F47)  
 Premium are Satin Anodized (F23R), Brushed (F98), and Stainless (F08)  
 Kynar: 32 in stock colors

**FIRE CODE:** Metal is non-combustible (ASTM E-84)

**PERF PATTERN:** Standard perf is "P8" = 1/8" diam. by 21/64" staggs  
 Other patterns available upon request

**PANEL LENGTH:** Standard length this profile is 12'-0"  
 Other lengths available upon request from 4' to 40'



**AMERICAN DECORATIVE CEILINGS**

(All Rights Reserved) ©2002/03/04

Mail: Post Office Box 605605 - Cleveland, Ohio 44105  
 Packages: 4510 East 71st St. - Cleveland, Ohio 44105  
 Telephone: (216) 341-2222  
 FAX: (216) 341-8501

R-9

# RIPPLE PAN #35D

## Section

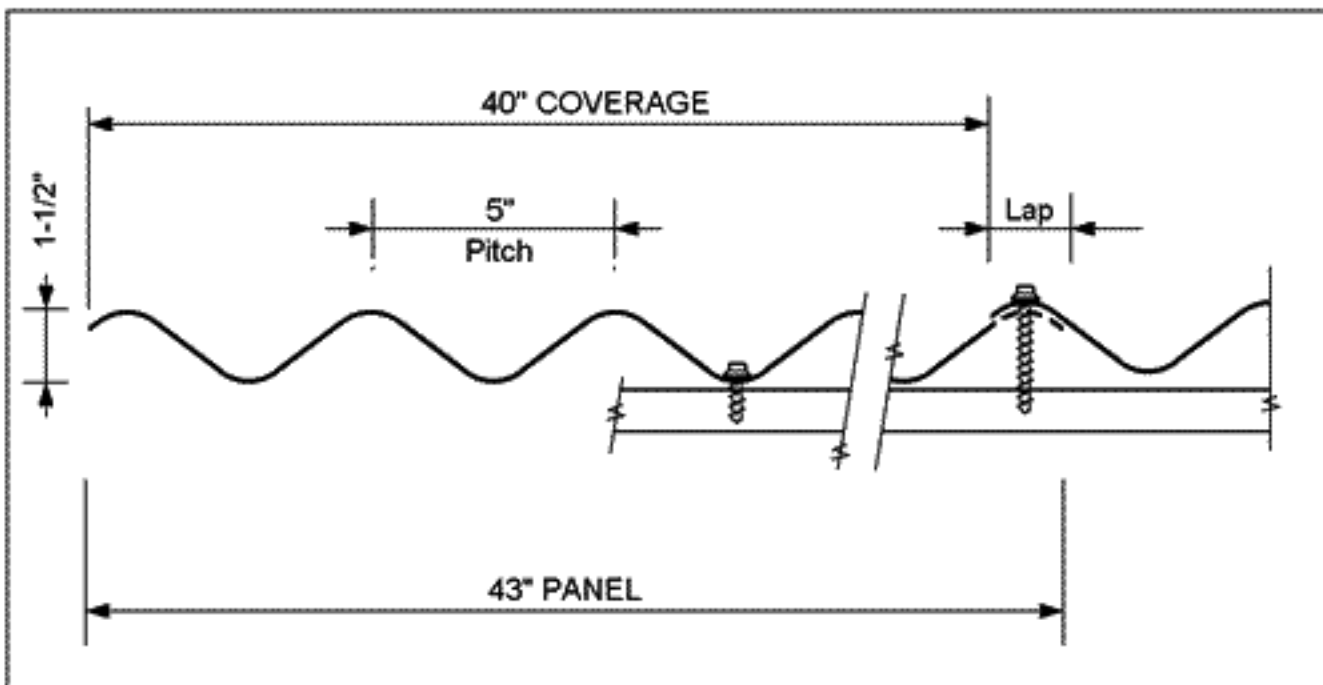

## Panel Data

MODEL NO.	THICK.	METAL	#/SF
<input type="checkbox"/> RP35D20A	0.020"	Aluminum	0.33#
<input type="checkbox"/> RP35D25A	0.025"	Aluminum	0.42#
<input type="checkbox"/> RP35D32A	0.032"	Aluminum	0.53#
<input type="checkbox"/> RP35D40A	0.040"	Aluminum	0.66#
<input type="checkbox"/> RP35D50A	0.050"	Aluminum	0.83#
<input type="checkbox"/> RP35D18G	26 GA. (.018")	Galvanized	0.86#
<input type="checkbox"/> RP35D24G	24 GA. (.024")	Galvanized	1.15#
<input type="checkbox"/> RP35D30G	22 GA. (.030")	Galvanized	1.44#

## Technical

**FINISH:** Standard are White (F41), Baron Ivory (F105), and Victorian Gray (F307)  
 Custom are electro statically applied poly-urethane epoxy paint (F47)  
 Premium are Satin Anodized (F23R), Brushed (F98), and Stainless (F08)  
 Kynar: 32 in stock colors

**FIRE CODE:** Metal is non-combustible (ASTM E-84)

**PERF PATTERN:** Standard perf is "P8" = 1/8" diam. by 21/64" staggs  
 Other patterns available upon request

**PANEL LENGTH:** Standard length this profile is 10'-0"  
 Other lengths available upon request from 2' to 10'



**AMERICAN DECORATIVE CEILINGS**

(All Rights Reserved) ©2010 AMP

Mail: Post Office Box 605605 - Cleveland, Ohio 44105  
 Packages: 4510 East 71st St. - Cleveland, Ohio 44105  
 Telephone: (216) 341-2222  
 FAX: (216) 341-8501

CSRP35D.BMP

# RIPPLE PAN #40D

## Section

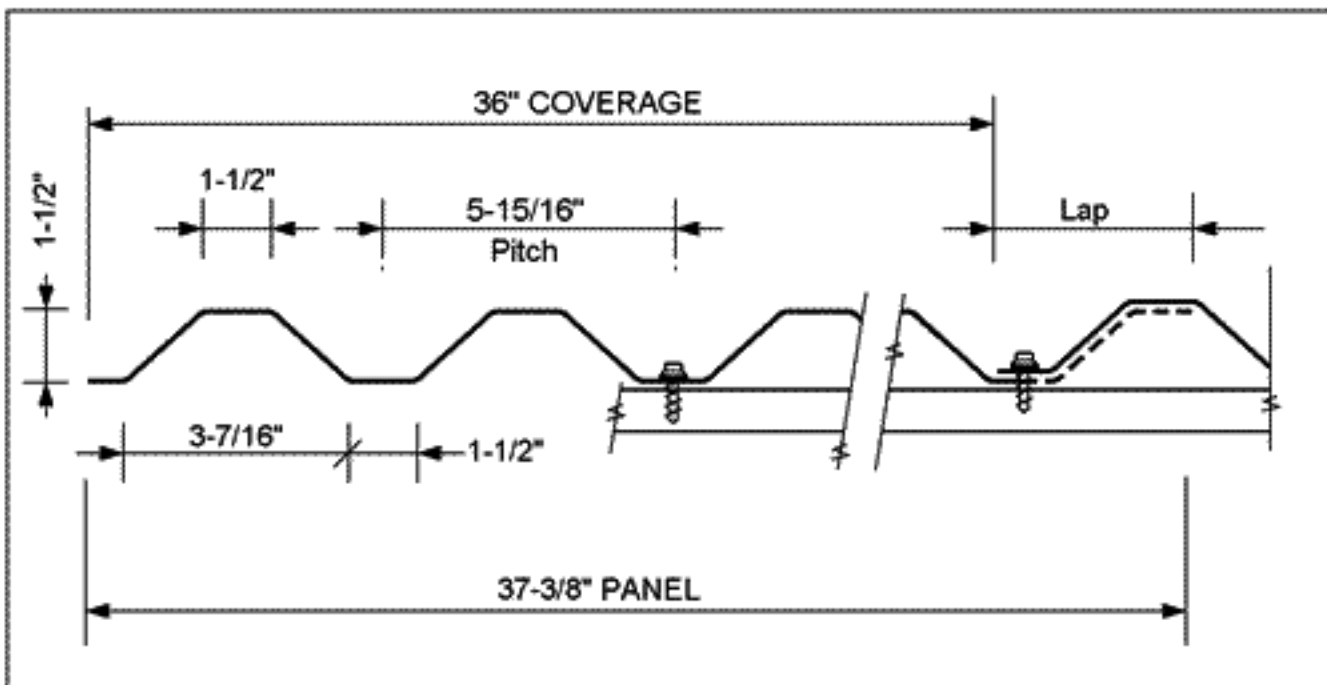

## Panel Data

MODEL NO.	THICK.	METAL	#/SF
<input type="checkbox"/> RP40D20A	0.020"	Aluminum	0.33#
<input type="checkbox"/> RP40D25A	0.025"	Aluminum	0.42#
<input type="checkbox"/> RP40D32A	0.032"	Aluminum	0.53#
<input type="checkbox"/> RP40D40A	0.040"	Aluminum	0.66#
<input type="checkbox"/> RP40D50A	0.050"	Aluminum	0.83#
<input type="checkbox"/> RP40D18G	26 GA. (.018")	Galvanized	0.86#
<input type="checkbox"/> RP40D24G	24 GA. (.024")	Galvanized	1.15#
<input type="checkbox"/> RP40D30G	22 GA. (.030")	Galvanized	1.44#

## Technical

**FINISH:** Standard are White (F41), Baron Ivory (F105), and Victorian Gray (F307)  
 Custom are electro statically applied poly-urethane epoxy paint (F47)  
 Premium are Satin Anodized (F23R), Brushed (F98), and Stainless (F08)  
 Kynar: 32 in stock colors

**FIRE CODE:** Metal is non-combustible (ASTM E-84)

**PERF PATTERN:** Standard perf is "P8" = 1/8" diam. by 21/64" staggs  
 Other patterns available upon request

**PANEL LENGTH:** Standard length this profile is 10'-0"  
 Other lengths available upon request from 2' to 10'



**AMERICAN DECORATIVE CEILINGS**

(All Rights Reserved) © 2004

Mail: Post Office Box 605605 - Cleveland, Ohio 44105  
 Packages: 4510 East 71st St. - Cleveland, Ohio 44105  
 Telephone: (216) 341-2222  
 FAX: (216) 341-8501



# RIPPLE PAN #41D

## Section

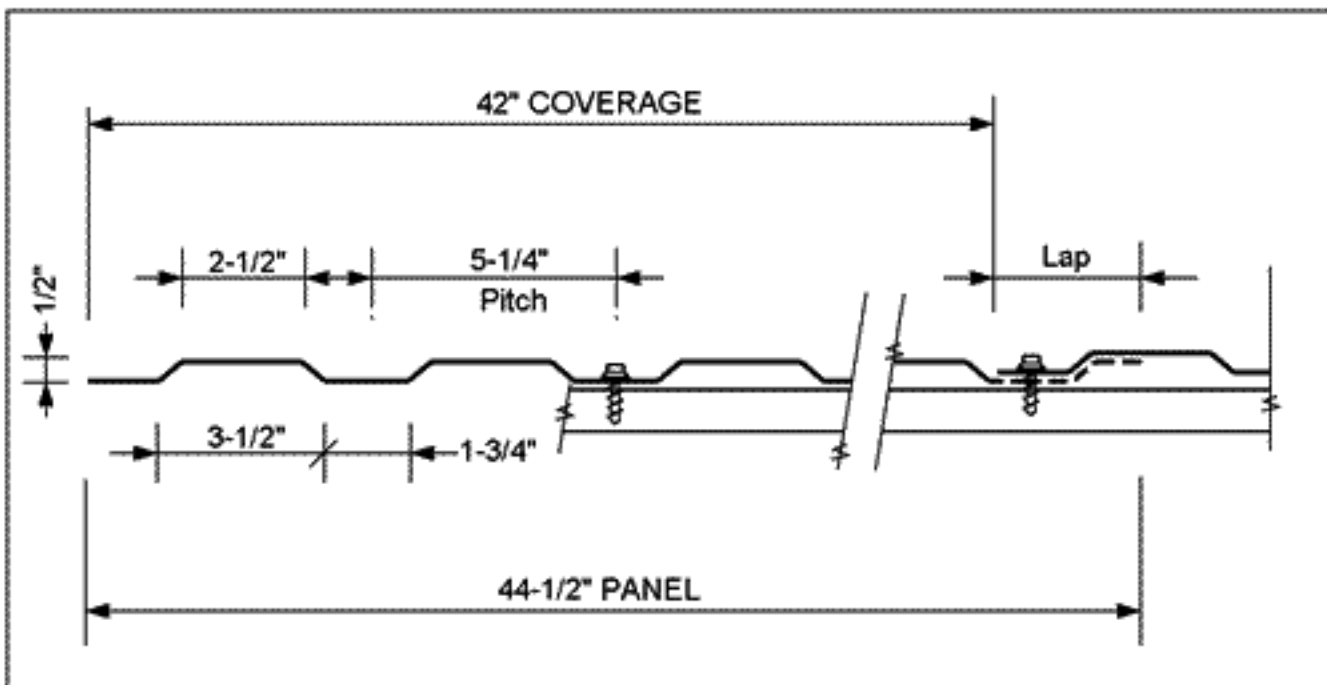

## Panel Data

MODEL NO.	THICK.	METAL	#/SF
<input type="checkbox"/> RP41D20A	0.020"	Aluminum	0.33#
<input type="checkbox"/> RP41D25A	0.025"	Aluminum	0.42#
<input type="checkbox"/> RP41D32A	0.032"	Aluminum	0.53#
<input type="checkbox"/> RP41D40A	0.040"	Aluminum	0.66#
<input type="checkbox"/> RP41D50A	0.050"	Aluminum	0.83#
<input type="checkbox"/> RP41D18G	26 GA. (.018")	Galvanized	0.86#
<input type="checkbox"/> RP41D24G	24 GA. (.024")	Galvanized	1.15#
<input type="checkbox"/> RP41D30G	22 GA. (.030")	Galvanized	1.44#

## Technical

**FINISH:** Standard are White (F41), Baron Ivory (F105), and Victorian Gray (F307)  
 Custom are electro statically applied poly-urethane epoxy paint (F47)  
 Premium are Satin Anodized (F23R), Brushed (F98), and Stainless (F08)  
 Kynar: 32 in stock colors

**FIRE CODE:** Metal is non-combustible (ASTM E-84)

**PERF PATTERN:** Standard perf is "P8" = 1/8" diam. by 21/64" staggs  
 Other patterns available upon request

**PANEL LENGTH:** Standard length this profile is 10'-0"  
 Other lengths available upon request from 2' to 10'



**AMERICAN DECORATIVE CEILINGS**

(All Rights Reserved) © 1998

Mail: Post Office Box 605605 - Cleveland, Ohio 44105  
 Packages: 4510 East 71st St. - Cleveland, Ohio 44105  
 Telephone: (216) 341-2222  
 FAX: (216) 341-8501

R-11

# RIPPLE PAN #50D

## Section

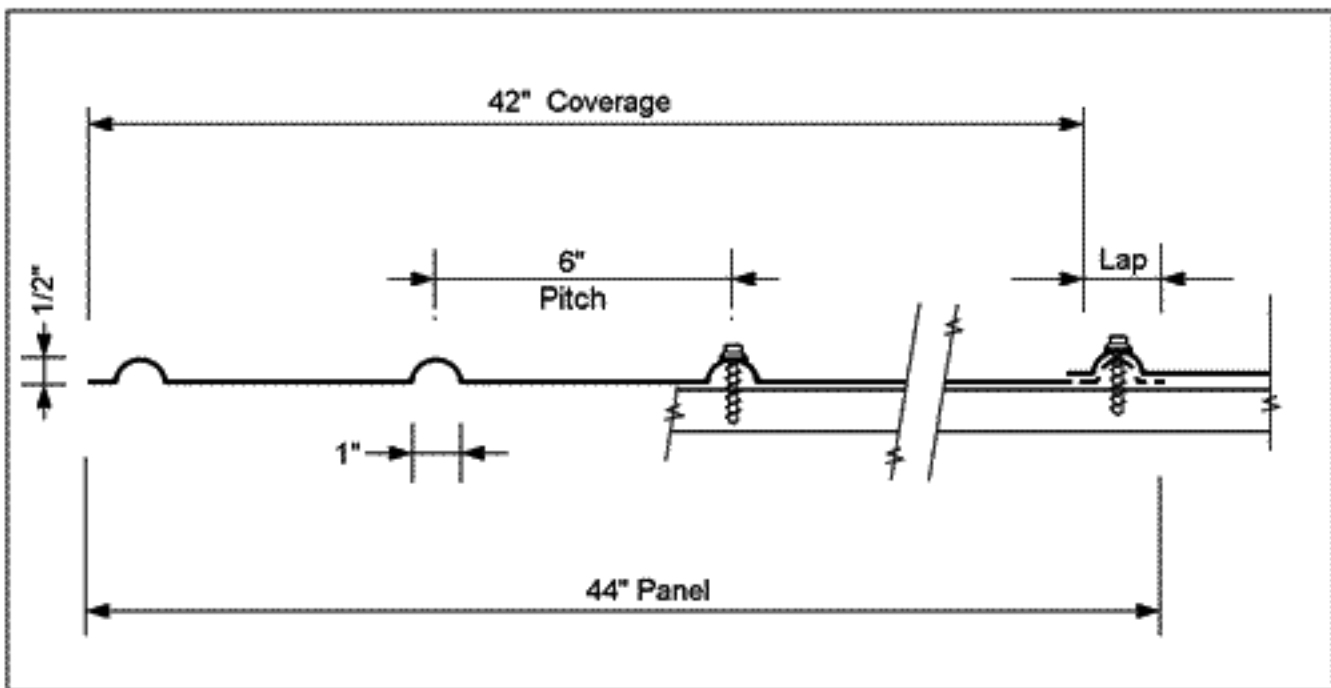

## Panel Data

MODEL NO.	THICK.	METAL	#/SF
<input type="checkbox"/> RP50D20A	0.020"	Aluminum	0.33#
<input type="checkbox"/> RP50D25A	0.025"	Aluminum	0.42#
<input type="checkbox"/> RP50D32A	0.032"	Aluminum	0.53#
<input type="checkbox"/> RP50D40A	0.040"	Aluminum	0.66#
<input type="checkbox"/> RP50D50A	0.050"	Aluminum	0.83#
<input type="checkbox"/> RP50D18G	26 GA. (.018")	Galvanized	0.86#
<input type="checkbox"/> RP50D24G	24 GA. (.024")	Galvanized	1.15#
<input type="checkbox"/> RP50D30G	22 GA. (.030")	Galvanized	1.44#

## Technical

**FINISH:** Standard are White (F41), Baron Ivory (F105), and Victorian Gray (F307)  
 Custom are electro statically applied poly-urethane epoxy paint (F47)  
 Premium are Satin Anodized (F23R), Brushed (F98), and Stainless (F08)  
 Kynar: 32 in stock colors

**FIRE CODE:** Metal is non-combustible (ASTM E-84)

**PERF PATTERN:** Standard perf is "P8" = 1/8" diam. by 21/64" staggs  
 Other patterns available upon request

**PANEL LENGTH:** Standard length this profile is 10'-0"  
 Other lengths available upon request from 2' to 10'



**AMERICAN DECORATIVE CEILINGS**

(All Rights Reserved) ©1990 A.D.C.

Mail: Post Office Box 605605 - Cleveland, Ohio 44105  
 Packages: 4510 East 71st St. - Cleveland, Ohio 44105  
 Telephone: (216) 341-2222  
 FAX: (216) 341-8501

# RIPPLE PAN #50X

## Section

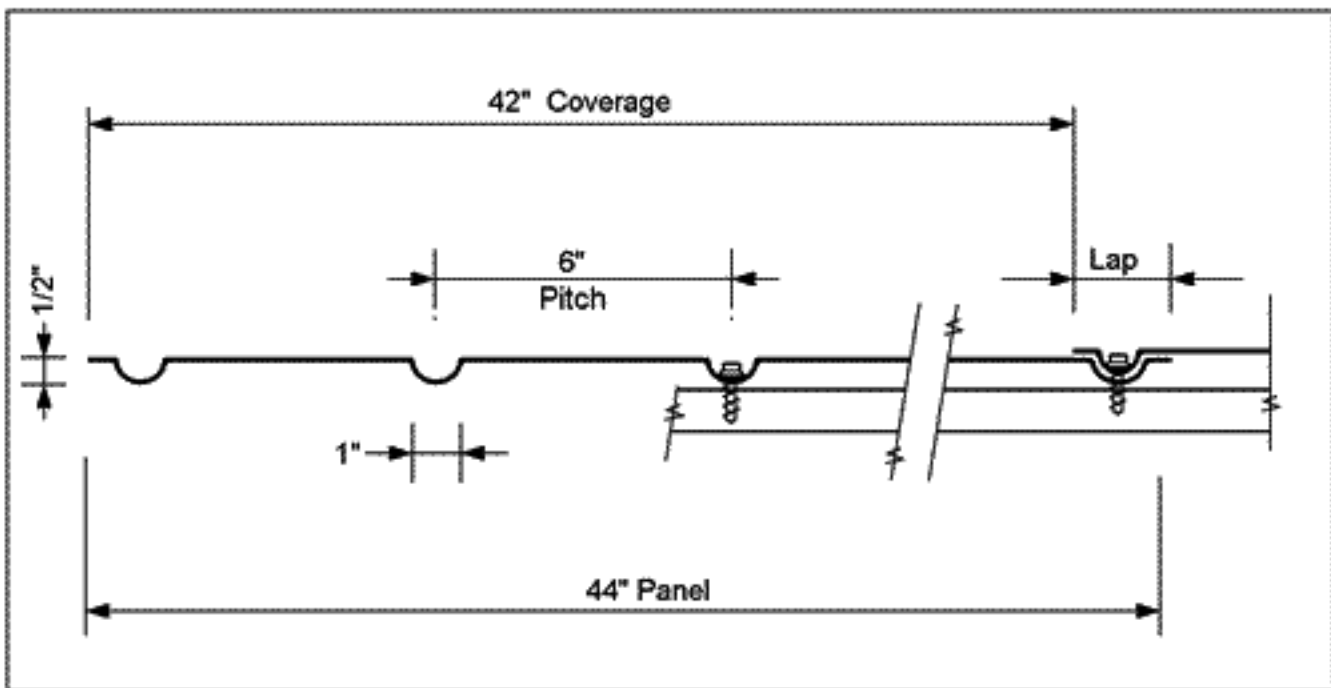

## Panel Data

MODEL NO.	THICK.	METAL	#/SF
<input type="checkbox"/> RP50X20A	0.020"	Aluminum	0.33#
<input type="checkbox"/> RP50X25A	0.025"	Aluminum	0.42#
<input type="checkbox"/> RP50X32A	0.032"	Aluminum	0.53#
<input type="checkbox"/> RP50X40A	0.040"	Aluminum	0.66#
<input type="checkbox"/> RP50X50A	0.050"	Aluminum	0.83#
<input type="checkbox"/> RP50X18G	26 GA. (.018")	Galvanized	0.86#
<input type="checkbox"/> RP50X24G	24 GA. (.024")	Galvanized	1.15#
<input type="checkbox"/> RP50X30G	22 GA. (.030")	Galvanized	1.44#

## Technical

**FINISH:** Standard are White (F41), Baron Ivory (F105), and Victorian Gray (F307)  
 Custom are electro statically applied poly-urethane epoxy paint (F47)  
 Premium are Satin Anodized (F23R), Brushed (F98), and Stainless (F08)  
 Kynar: 32 in stock colors

**FIRE CODE:** Metal is non-combustible (ASTM E-84)

**PERF PATTERN:** Standard perf is "P8" = 1/8" diam. by 21/64" staggs  
 Other patterns available upon request

**PANEL LENGTH:** Standard length this profile is 10'-0"  
 Other lengths available upon request from 2' to 10'



**AMERICAN DECORATIVE CEILINGS**

(All Rights Reserved) COMPASS

Mail: Post Office Box 605605 - Cleveland, Ohio 44105  
 Packages: 4510 East 71st St. - Cleveland, Ohio 44105  
 Telephone: (216) 341-2222  
 FAX: (216) 341-8501

R-13

# RIPPLE PAN #60D

## Section

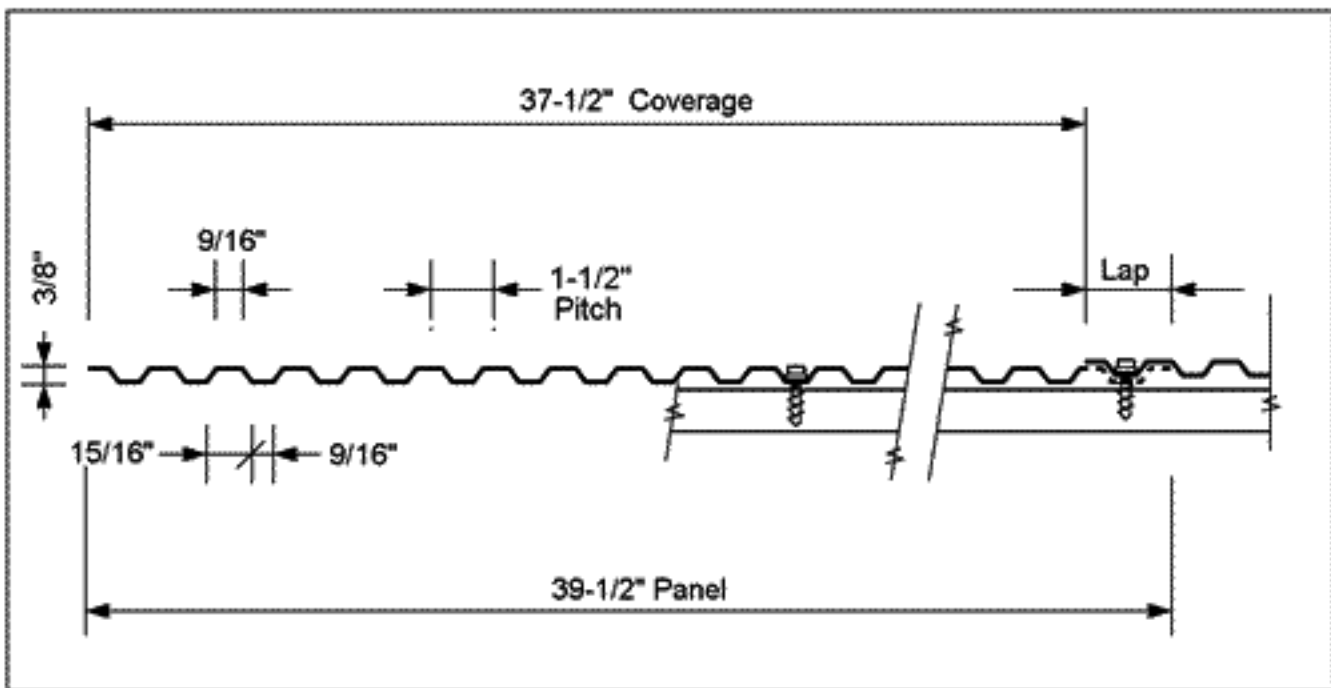

## Panel Data

MODEL NO.	THICK.	METAL	#/SF
<input type="checkbox"/> RP60D20A	0.020"	Aluminum	0.33#
<input type="checkbox"/> RP60D25A	0.025"	Aluminum	0.42#
<input type="checkbox"/> RP60D32A	0.032"	Aluminum	0.53#
<input type="checkbox"/> RP60D40A	0.040"	Aluminum	0.66#
<input type="checkbox"/> RP60D50A	0.050"	Aluminum	0.83#
<input type="checkbox"/> RP60D18G	26 GA. (.018")	Galvanized	0.86#
<input type="checkbox"/> RP60D24G	24 GA. (.024")	Galvanized	1.15#
<input type="checkbox"/> RP60D30G	22 GA. (.030")	Galvanized	1.44#

## Technical

**FINISH:** Standard are White (F41), Baron Ivory (F105), and Victorian Gray (F307)  
 Custom are electro statically applied poly-urethane epoxy paint (F47)  
 Premium are Satin Anodized (F23R), Brushed (F98), and Stainless (F08)  
 Kynar: 32 in stock colors

**FIRE CODE:** Metal is non-combustible (ASTM E-84)

**PERF PATTERN:** Standard perf is "P8" = 1/8" diam. by 21/64" staggs  
 Other patterns available upon request

**PANEL LENGTH:** Standard length this profile is 10'-0"  
 Other lengths available upon request from 2' to 10'



**AMERICAN DECORATIVE CEILINGS**

(All Rights Reserved) [www.adc.com](http://www.adc.com)

Mail: Post Office Box 605605 - Cleveland, Ohio 44105  
 Packages: 4510 East 71st St. - Cleveland, Ohio 44105  
 Telephone: (216) 341-2222  
 FAX: (216) 341-8501

# RIPPLE PAN #61D

## Section

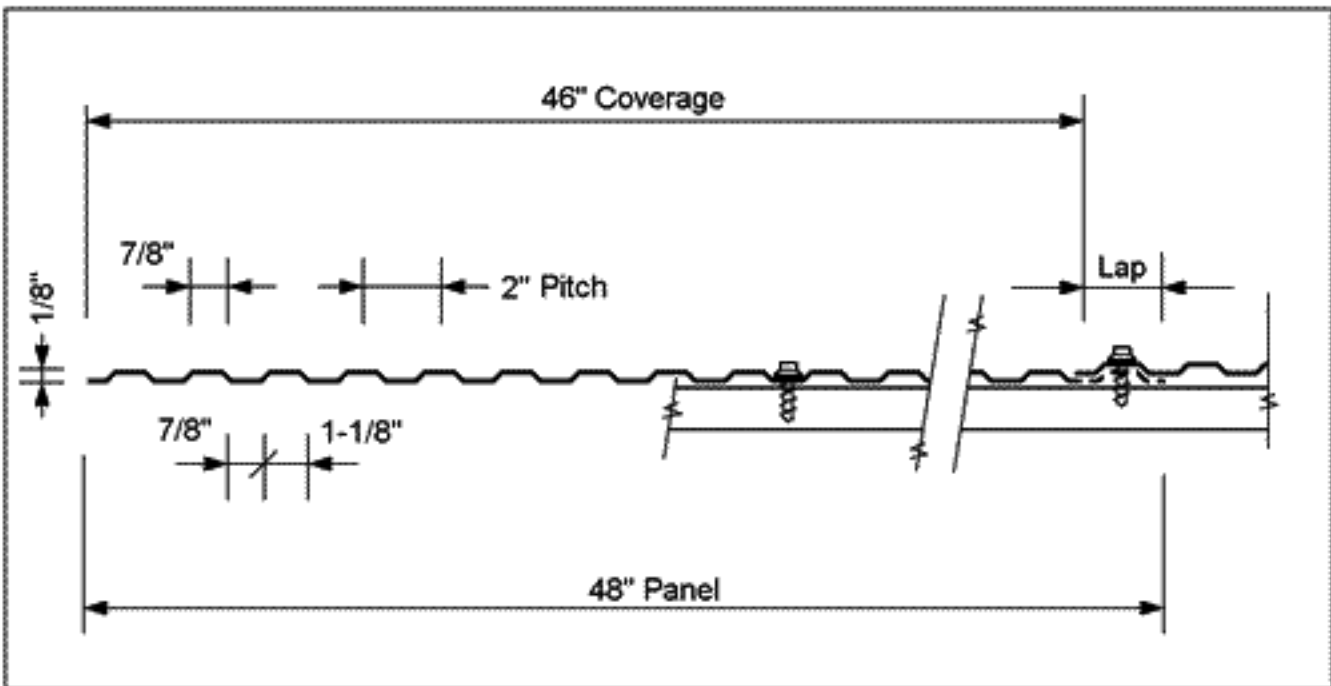

## Panel Data

MODEL NO.	THICK.	METAL	#/SF
<input type="checkbox"/> RP61D20A	0.020"	Aluminum	0.33#
<input type="checkbox"/> RP61D25A	0.025"	Aluminum	0.42#
<input type="checkbox"/> RP61D32A	0.032"	Aluminum	0.53#
<input type="checkbox"/> RP61D40A	0.040"	Aluminum	0.66#
<input type="checkbox"/> RP61D50A	0.050"	Aluminum	0.83#
<input type="checkbox"/> RP61D18G	26 GA. (.018")	Galvanized	0.86#
<input type="checkbox"/> RP61D24G	24 GA. (.024")	Galvanized	1.15#
<input type="checkbox"/> RP61D30G	22 GA. (.030")	Galvanized	1.44#

## Technical

**FINISH:** Standard are White (F41), Baron Ivory (F105), and Victorian Gray (F307)  
 Custom are electro statically applied poly-urethane epoxy paint (F47)  
 Premium are Satin Anodized (F23R), Brushed (F98), and Stainless (F08)  
 Kynar: 32 in stock colors

**FIRE CODE:** Metal is non-combustible (ASTM E-84)

**PERF PATTERN:** Standard perf is "P8" = 1/8" diam. by 21/64" staggs  
 Other patterns available upon request

**PANEL LENGTH:** Standard length this profile is 12'-0"  
 Other lengths available upon request from 4' to 40'



**AMERICAN DECORATIVE CEILINGS**

(All Rights Reserved) ©1998/2000

Mail: Post Office Box 605605 - Cleveland, Ohio 44105  
 Packages: 4510 East 71st St. - Cleveland, Ohio 44105  
 Telephone: (216) 341-2222  
 FAX: (216) 341-8501

R-15

# RIPPLE PAN #62R

## Section

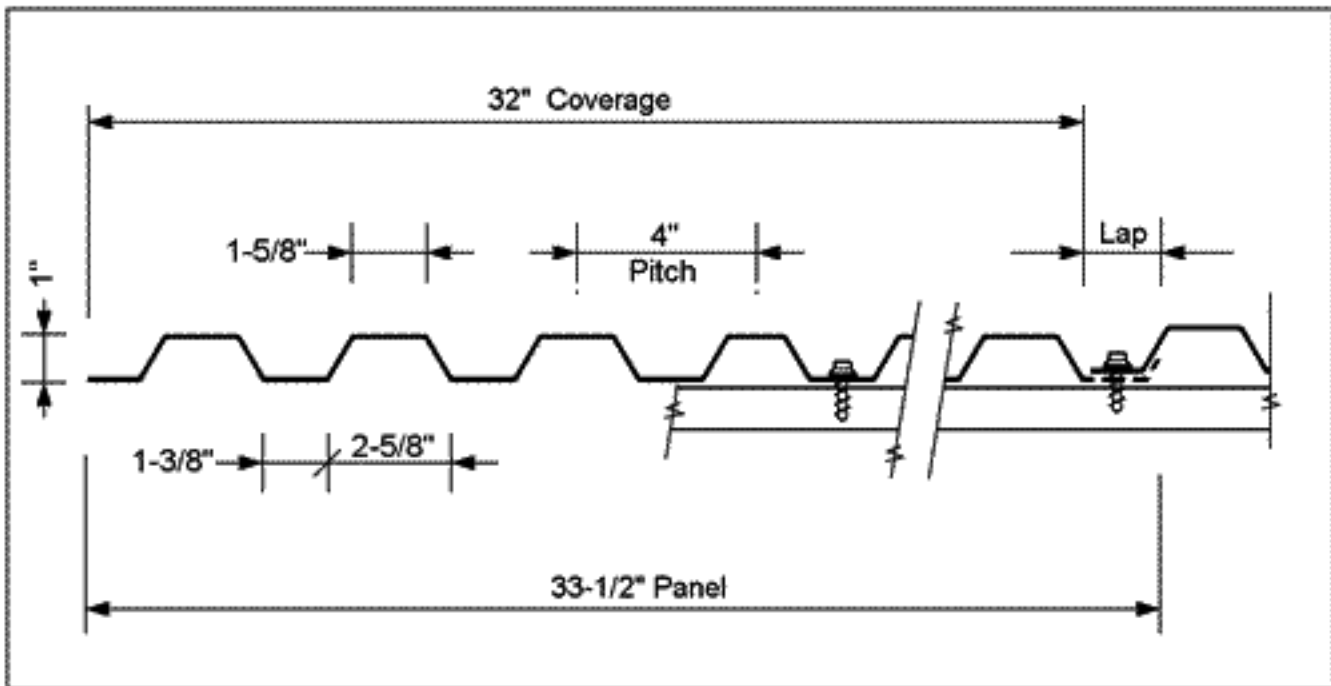

## Panel Data

MODEL NO.	THICK.	METAL	#/SF
<input type="checkbox"/> RP62R20A	0.020"	Aluminum	0.33#
<input type="checkbox"/> RP62R25A	0.025"	Aluminum	0.42#
<input type="checkbox"/> RP62R32A	0.032"	Aluminum	0.53#
<input type="checkbox"/> RP62R40A	0.040"	Aluminum	0.66#
<input type="checkbox"/> RP62R50A	0.050"	Aluminum	0.83#
<input type="checkbox"/> RP62R18G	26 GA. (.018")	Galvanized	0.86#
<input type="checkbox"/> RP62R24G	24 GA. (.024")	Galvanized	1.15#
<input type="checkbox"/> RP62R30G	22 GA. (.030")	Galvanized	1.44#

## Technical

**FINISH:** Standard are White (F41), Baron Ivory (F105), and Victorian Gray (F307)  
 Custom are electro statically applied poly-urethane epoxy paint (F47)  
 Premium are Satin Anodized (F23R), Brushed (F98), and Stainless (F08)  
 Kynar: 32 in stock colors

**FIRE CODE:** Metal is non-combustible (ASTM E-84)

**PERF PATTERN:** Standard perf is "P8" = 1/8" diam. by 21/64" staggs  
 Other patterns available upon request

**PANEL LENGTH:** Standard length this profile is 12'-0"  
 Other lengths available upon request from 4' to 40'



**AMERICAN DECORATIVE CEILINGS**

(All Rights Reserved) ©2002

Mail: Post Office Box 605605 - Cleveland, Ohio 44105  
 Packages: 4510 East 71st St. - Cleveland, Ohio 44105  
 Telephone: (216) 341-2222  
 FAX: (216) 341-8501

# RIPPLE PAN #63D

## Section

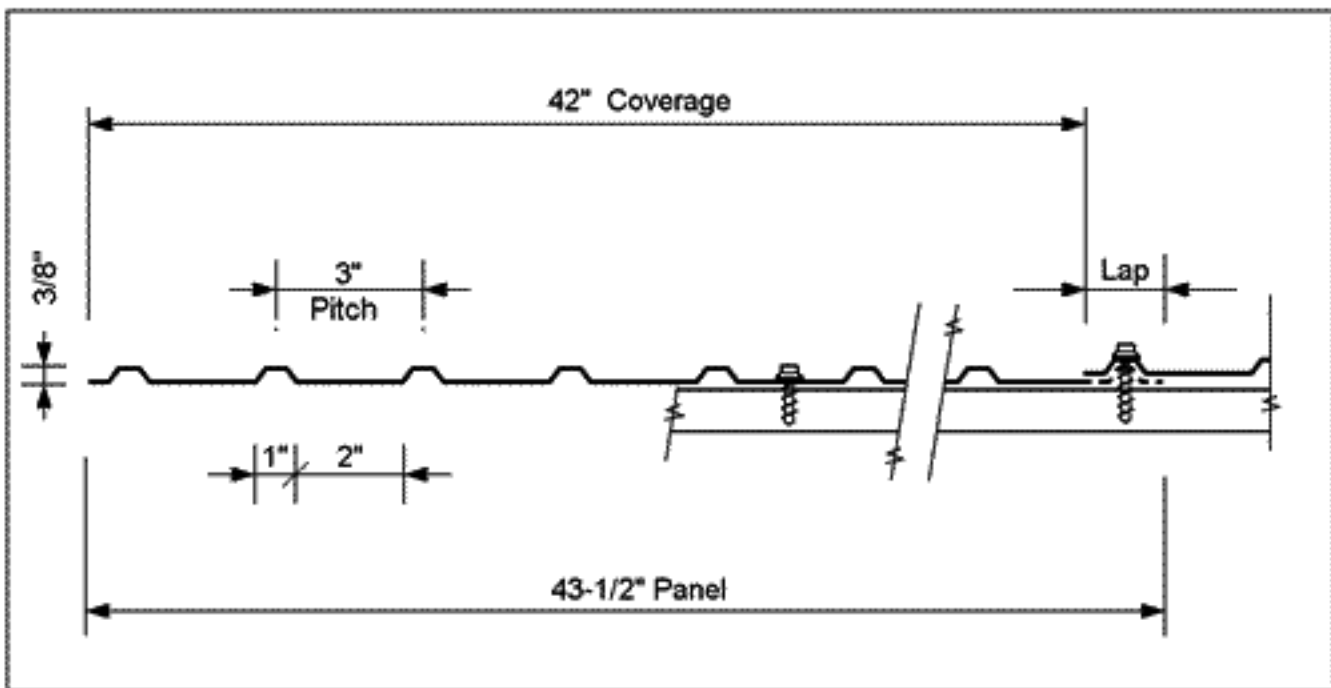

## Panel Data

MODEL NO.	THICK.	METAL	#/SF
<input type="checkbox"/> RP63D20A	0.020"	Aluminum	0.33#
<input type="checkbox"/> RP63D25A	0.025"	Aluminum	0.42#
<input type="checkbox"/> RP63D32A	0.032"	Aluminum	0.53#
<input type="checkbox"/> RP63D40A	0.040"	Aluminum	0.66#
<input type="checkbox"/> RP63D50A	0.050"	Aluminum	0.83#
<input type="checkbox"/> RP63D18G	26 GA. (.018")	Galvanized	0.86#
<input type="checkbox"/> RP63D24G	24 GA. (.024")	Galvanized	1.15#
<input type="checkbox"/> RP63D30G	22 GA. (.030")	Galvanized	1.44#

## Technical

**FINISH:** Standard are White (F41), Baron Ivory (F105), and Victorian Gray (F307)  
 Custom are electro statically applied poly-urethane epoxy paint (F47)  
 Premium are Satin Anodized (F23R), Brushed (F98), and Stainless (F08)  
 Kynar: 32 in stock colors

**FIRE CODE:** Metal is non-combustible (ASTM E-84)

**PERF PATTERN:** Standard perf is "P8" = 1/8" diam. by 21/64" staggs  
 Other patterns available upon request

**PANEL LENGTH:** Standard length this profile is 10'-0"  
 Other lengths available upon request from 2' to 10'



**AMERICAN DECORATIVE CEILINGS**

(All Rights Reserved) © 2000

Mail: Post Office Box 605605 - Cleveland, Ohio 44105  
 Packages: 4510 East 71st St. - Cleveland, Ohio 44105  
 Telephone: (216) 341-2222  
 FAX: (216) 341-8501

R-17

# RIPPLE PAN #63X

## Section

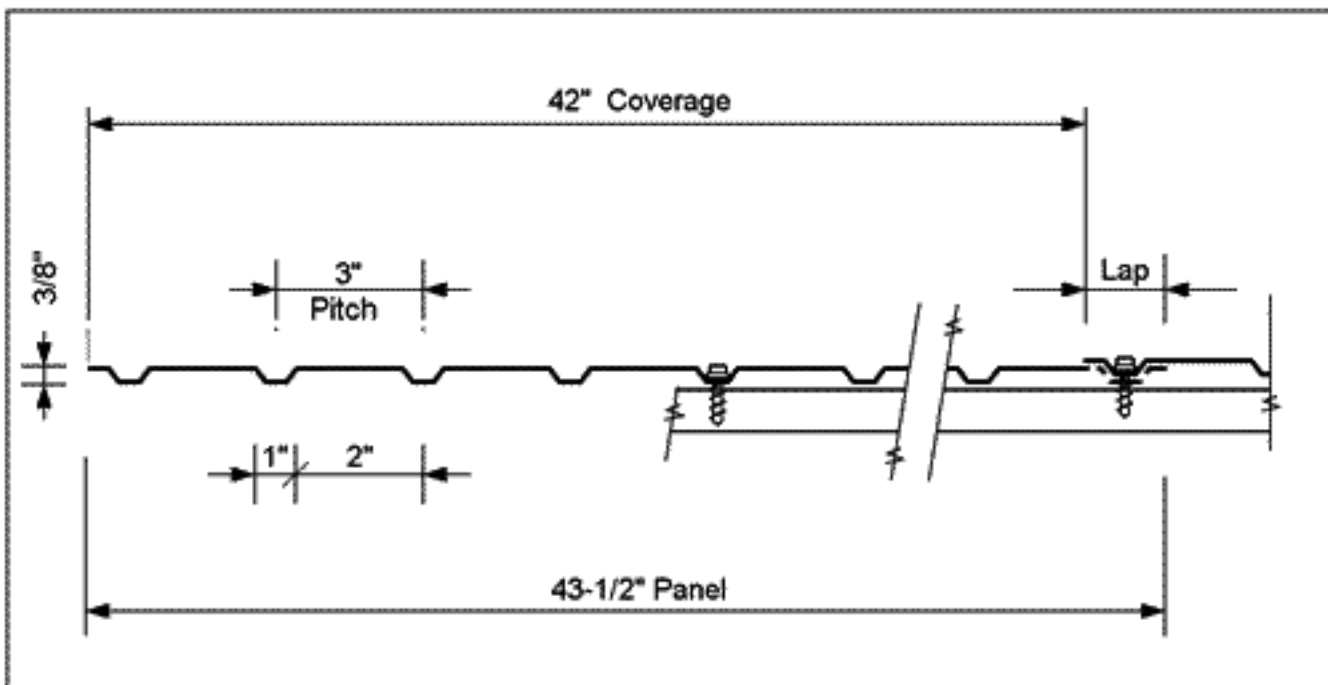

## Panel Data

MODEL NO.	THICK.	METAL	#/SF
<input type="checkbox"/> RP63X20A	0.020"	Aluminum	0.33#
<input type="checkbox"/> RP63X25A	0.025"	Aluminum	0.42#
<input type="checkbox"/> RP63X32A	0.032"	Aluminum	0.53#
<input type="checkbox"/> RP63X40A	0.040"	Aluminum	0.66#
<input type="checkbox"/> RP63X50A	0.050"	Aluminum	0.83#
<input type="checkbox"/> RP63X18G	26 GA. (.018")	Galvanized	0.86#
<input type="checkbox"/> RP63X24G	24 GA. (.024")	Galvanized	1.15#
<input type="checkbox"/> RP63X30G	22 GA. (.030")	Galvanized	1.44#

## Technical

**FINISH:** Standard are White (F41), Baron Ivory (F105), and Victorian Gray (F307)  
 Custom are electro statically applied poly-urethane epoxy paint (F47)  
 Premium are Satin Anodized (F23R), Brushed (F98), and Stainless (F08)  
 Kynar: 32 in stock colors

**FIRE CODE:** Metal is non-combustible (ASTM E-84)

**PERF PATTERN:** Standard perf is "P8" = 1/8" diam. by 21/64" staggs  
 Other patterns available upon request

**PANEL LENGTH:** Standard length this profile is 10'-0"  
 Other lengths available upon request from 2' to 10'



**AMERICAN DECORATIVE CEILINGS**

(All Rights Reserved) ©1992/00/00

Mail: Post Office Box 605605 - Cleveland, Ohio 44105  
 Packages: 4510 East 71st St. - Cleveland, Ohio 44105  
 Telephone: (216) 341-2222  
 FAX: (216) 341-8501



# RIPPLE PAN #64D

## Section

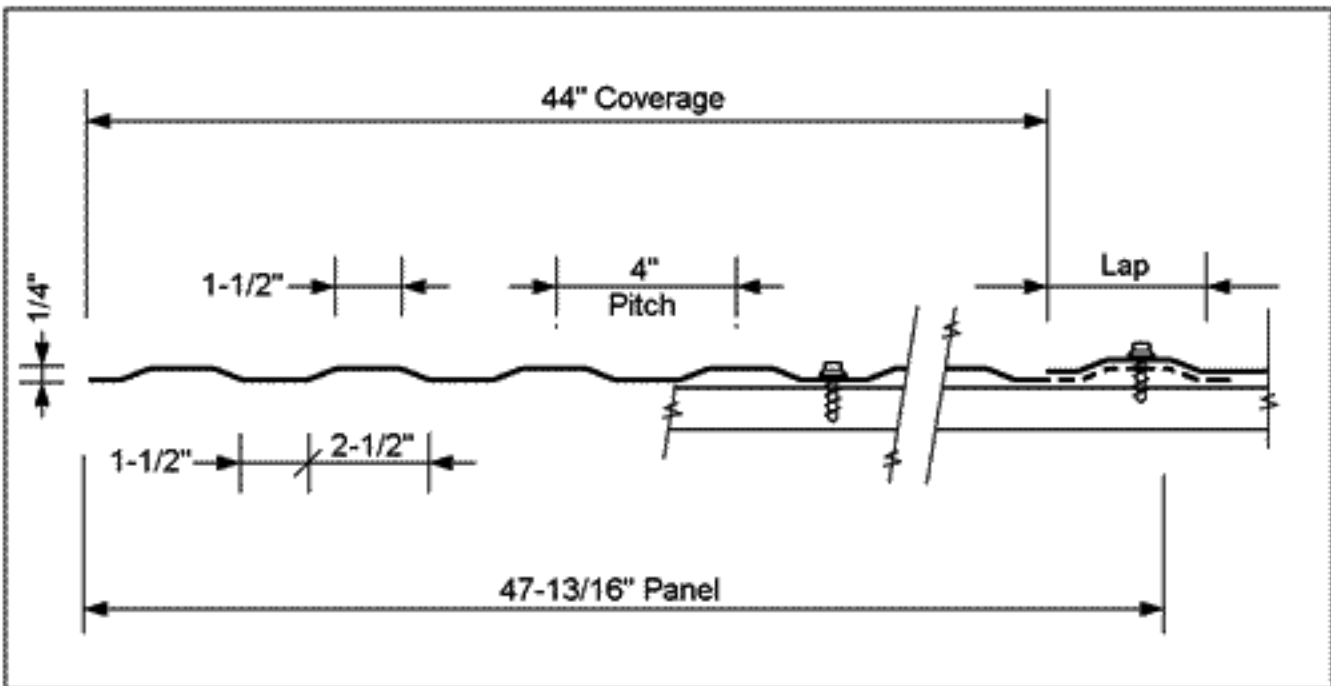

## Panel Data

MODEL NO.	THICK.	METAL	#/SF
<input type="checkbox"/> RP64D20A	0.020"	Aluminum	0.33#
<input type="checkbox"/> RP64D25A	0.025"	Aluminum	0.42#
<input type="checkbox"/> RP64D32A	0.032"	Aluminum	0.53#
<input type="checkbox"/> RP64D40A	0.040"	Aluminum	0.66#
<input type="checkbox"/> RP64D50A	0.050"	Aluminum	0.83#
<input type="checkbox"/> RP64D18G	26 GA. (.018")	Galvanized	0.86#
<input type="checkbox"/> RP64D24G	24 GA. (.024")	Galvanized	1.15#
<input type="checkbox"/> RP64D30G	22 GA. (.030")	Galvanized	1.44#

## Technical

**FINISH:** Standard are White (F41), Baron Ivory (F105), and Victorian Gray (F307)  
 Custom are electro statically applied poly-urethane epoxy paint (F47)  
 Premium are Satin Anodized (F23R), Brushed (F98), and Stainless (F08)  
 Kynar: 32 in stock colors

**FIRE CODE:** Metal is non-combustible (ASTM E-84)

**PERF PATTERN:** Standard perf is "P8" = 1/8" diam. by 21/64" staggs  
 Other patterns available upon request

**PANEL LENGTH:** Standard length this profile is 12'-0"  
 Other lengths available upon request from 4' to 40'



**AMERICAN DECORATIVE CEILINGS**

(All Rights Reserved) [www.americandecorative.com](http://www.americandecorative.com)

Mail: Post Office Box 605605 - Cleveland, Ohio 44105  
 Packages: 4510 East 71st St. - Cleveland, Ohio 44105  
 Telephone: (216) 341-2222  
 FAX: (216) 341-8501

R-19

# RIPPLE PAN #80D

## Section

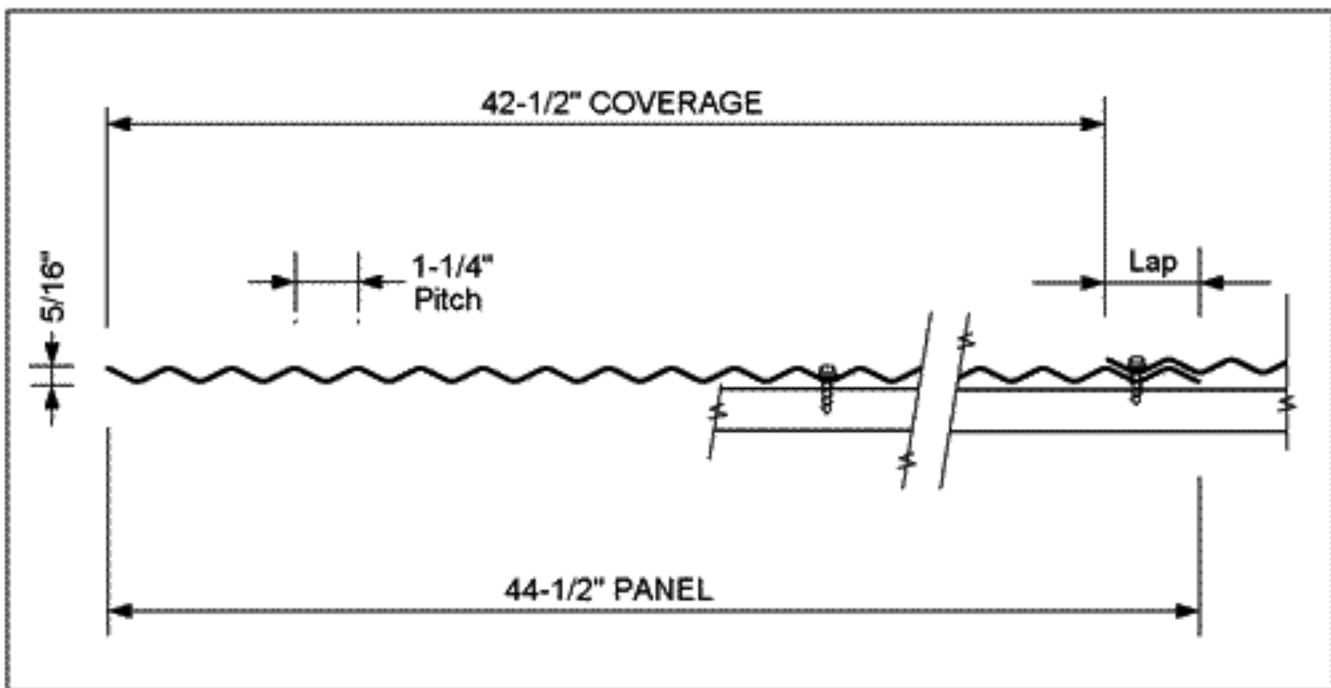

## Panel Data

MODEL NO.	THICK.	METAL	#/SF
<input type="checkbox"/> RP80D20A	0.020"	Aluminum	0.33#
<input type="checkbox"/> RP80D25A	0.025"	Aluminum	0.42#
<input type="checkbox"/> RP80D32A	0.032"	Aluminum	0.53#
<input type="checkbox"/> RP80D40A	0.040"	Aluminum	0.66#
<input type="checkbox"/> RP80D50A	0.050"	Aluminum	0.83#
<input type="checkbox"/> RP80D18G	26 GA. (.018")	Galvanized	0.86#
<input type="checkbox"/> RP80D24G	24 GA. (.024")	Galvanized	1.15#
<input type="checkbox"/> RP80D30G	22 GA. (.030")	Galvanized	1.44#

## Technical

**FINISH:** Standard are White (F41), Baron Ivory (F105), and Victorian Gray (F307)  
 Custom are electro statically applied poly-urethane epoxy paint (F47)  
 Premium are Satin Anodized (F23R), Brushed (F98), and Stainless (F08)  
 Kynar: 32 in stock colors

**FIRE CODE:** Metal is non-combustible (ASTM E-84)

**PERF PATTERN:** Standard perf is "P8" = 1/8" diam. by 21/64" staggs  
 Other patterns available upon request

**PANEL LENGTH:** Standard length this profile is 10'-0"  
 Other lengths available upon request from 2' to 10'



**AMERICAN DECORATIVE CEILINGS**

(All Rights Reserved) © 1998

Mail: Post Office Box 605605 - Cleveland, Ohio 44105  
 Packages: 4510 East 71st St. - Cleveland, Ohio 44105  
 Telephone: (216) 341-2222  
 FAX: (216) 341-8501

# RIPPLE PAN #81D

## Section

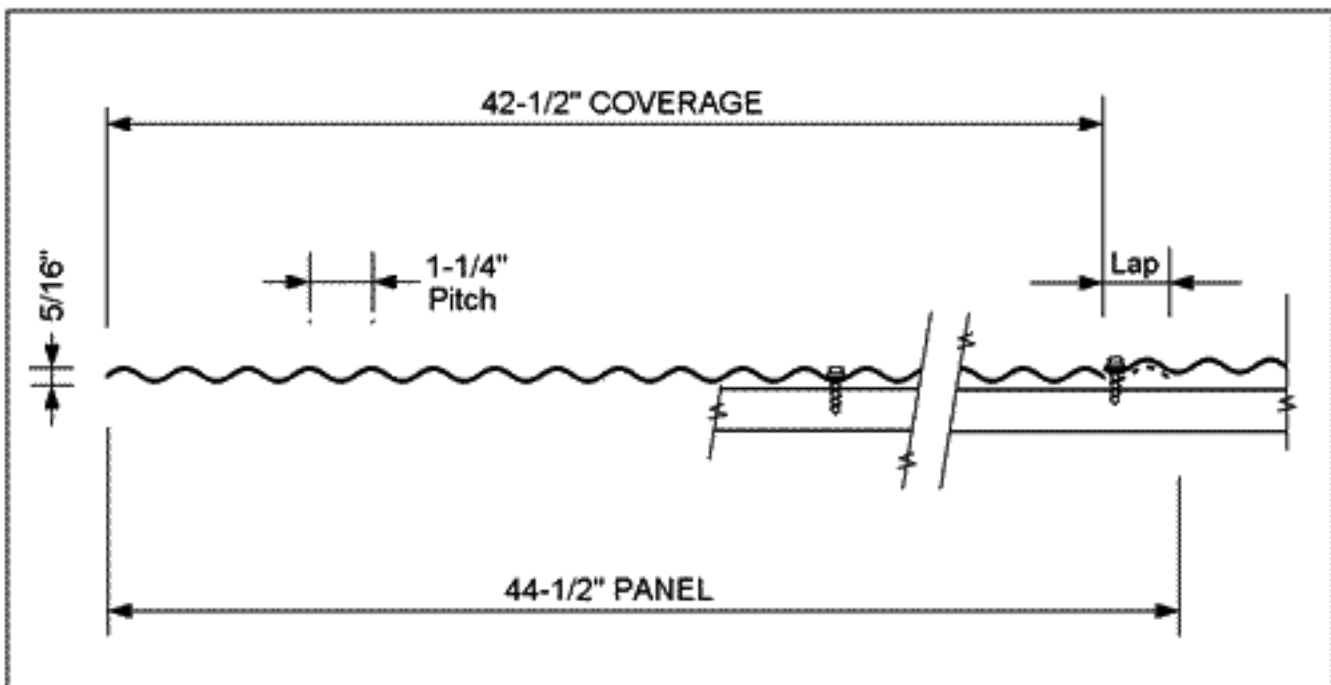

## Panel Data

MODEL NO.	THICK.	METAL	#/SF
<input type="checkbox"/> RP81D20A	0.020"	Aluminum	0.33#
<input type="checkbox"/> RP81D25A	0.025"	Aluminum	0.42#
<input type="checkbox"/> RP81D32A	0.032"	Aluminum	0.53#
<input type="checkbox"/> RP81D40A	0.040"	Aluminum	0.66#
<input type="checkbox"/> RP81D50A	0.050"	Aluminum	0.83#
<input type="checkbox"/> RP81D18G	26 GA. (.018")	Galvanized	0.86#
<input type="checkbox"/> RP81D24G	24 GA. (.024")	Galvanized	1.15#
<input type="checkbox"/> RP81D30G	22 GA. (.030")	Galvanized	1.44#

## Technical

**FINISH:** Standard are White (F41), Baron Ivory (F105), and Victorian Gray (F307)  
 Custom are electro statically applied poly-urethane epoxy paint  
 Premium are Satin Anodized (F23R), Brushed (F98), and Stainless (F08)  
 Kynar: 32 in stock colors

**FIRE CODE:** Metal is non-combustible (ASTM E-84)

**PERF PATTERN:** Standard perf is "P8" = 1/8" diam. by 21/64" staggs  
 Other patterns available upon request

**PANEL LENGTH:** Standard length this profile is 10'-0"  
 Other lengths available upon request from 4' to 10'



**AMERICAN DECORATIVE CEILINGS**

(All Rights Reserved) [www.americandecorativeceilings.com](http://www.americandecorativeceilings.com)

Mail: Post Office Box 605605 - Cleveland, Ohio 44105  
 Packages: 4510 East 71st St. - Cleveland, Ohio 44105  
 Telephone: (216) 341-2222  
 FAX: (216) 341-8501

R-21

# RIPPLE PAN #90A

## Section

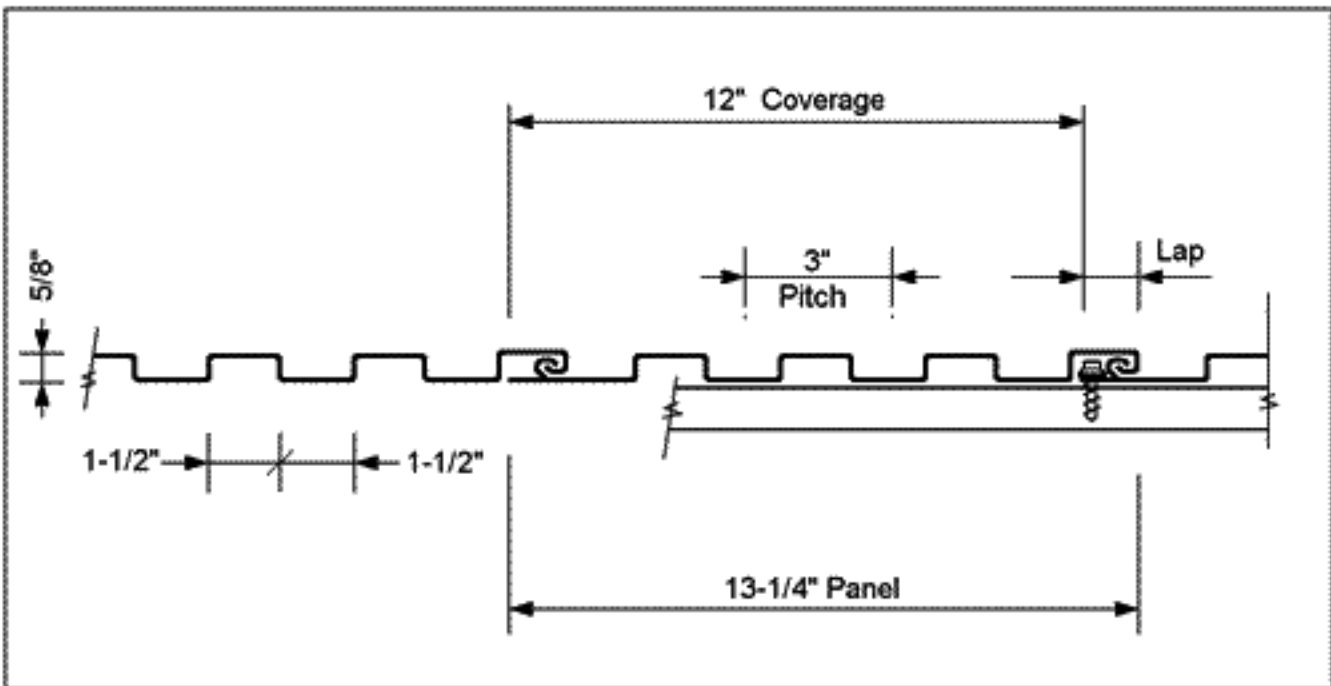

## Panel Data

MODEL NO.	THICK.	METAL	#/SF
<input type="checkbox"/> RP90A20A	0.020"	Aluminum	0.33#
<input type="checkbox"/> RP90A25A	0.025"	Aluminum	0.42#
<input type="checkbox"/> RP90A32A	0.032"	Aluminum	0.53#
<input type="checkbox"/> RP90A40A	0.040"	Aluminum	0.66#
<input type="checkbox"/> RP90A50A	0.050"	Aluminum	0.83#
<input type="checkbox"/> RP90A18G	26 GA. (.018")	Galvanized	0.86#
<input type="checkbox"/> RP90A24G	24 GA. (.024")	Galvanized	1.15#
<input type="checkbox"/> RP90A30G	22 GA. (.030")	Galvanized	1.44#

## Technical

**FINISH:** Standard are White (F41), Baron Ivory (F105), and Victorian Gray (F307)  
 Custom are electro statically applied poly-urethane epoxy paint (F47)  
 Premium are Satin Anodized (F23R), Brushed (F98), and Stainless (F08)  
 Kynar: 32 in stock colors

**FIRE CODE:** Metal is non-combustible (ASTM E-84)

**PERF PATTERN:** Standard perf is "P8" = 1/8" diam. by 21/64" staggs  
 Other patterns available upon request

**PANEL LENGTH:** Standard length this profile is 12'-0"  
 Other lengths available upon request from 4' to 40'



**AMERICAN DECORATIVE CEILINGS**

(All Rights Reserved) [www.ace.com](http://www.ace.com)

4158 East 71st St. - Cleveland, Ohio 44105

Telephone: (216) 341-2222

FAX: (216) 341-8501

# RIPPLE PAN #91D

## Section

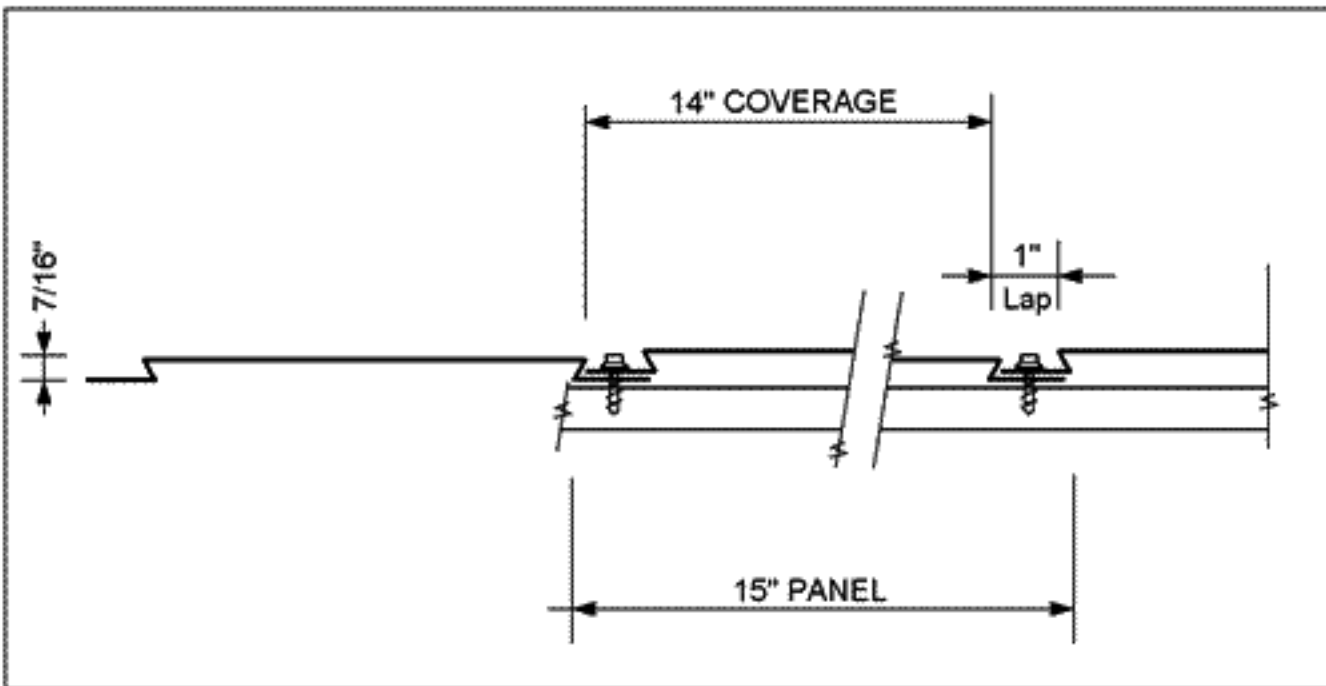

## Panel Data

MODEL NO.	THICK.	METAL	#/SF
<input type="checkbox"/> RP91D20A	0.020"	Aluminum	0.33#
<input type="checkbox"/> RP91D25A	0.025"	Aluminum	0.42#
<input type="checkbox"/> RP91D32A	0.032"	Aluminum	0.53#
<input type="checkbox"/> RP91D40A	0.040"	Aluminum	0.66#
<input type="checkbox"/> RP91D50A	0.050"	Aluminum	0.83#
<input type="checkbox"/> RP91D18G	26 GA. (.018")	Galvanized	0.86#
<input type="checkbox"/> RP91D24G	24 GA. (.024")	Galvanized	1.15#
<input type="checkbox"/> RP91D30G	22 GA. (.030")	Galvanized	1.44#

## Technical

**FINISH:** Standard are White (F41), Baron Ivory (F105), and Victorian Gray (F307)  
 Custom are electro statically applied poly-urethane epoxy paint (F47)  
 Premium are Satin Anodized (F23R), Brushed (F98), and Stainless (F08)  
 Kynar: 32 in stock colors

**FIRE CODE:** Metal is non-combustible (ASTM E-84)

**PERF PATTERN:** Standard perf is "P8" = 1/8" diam. by 21/64" staggs  
 Other patterns available upon request

**PANEL LENGTH:** Standard length this profile is 12'-0"  
 Other lengths available upon request from 2' to 12'



**AMERICAN DECORATIVE CEILINGS**

(All Rights Reserved) ©1998

Mail: Post Office Box 605605 - Cleveland, Ohio 44105  
 Packages: 4510 East 71st St. - Cleveland, Ohio 44105  
 Telephone: (216) 341-2222  
 FAX: (216) 341-8501

R-25

# RIPPLE PAN - QUANTUM

## Section

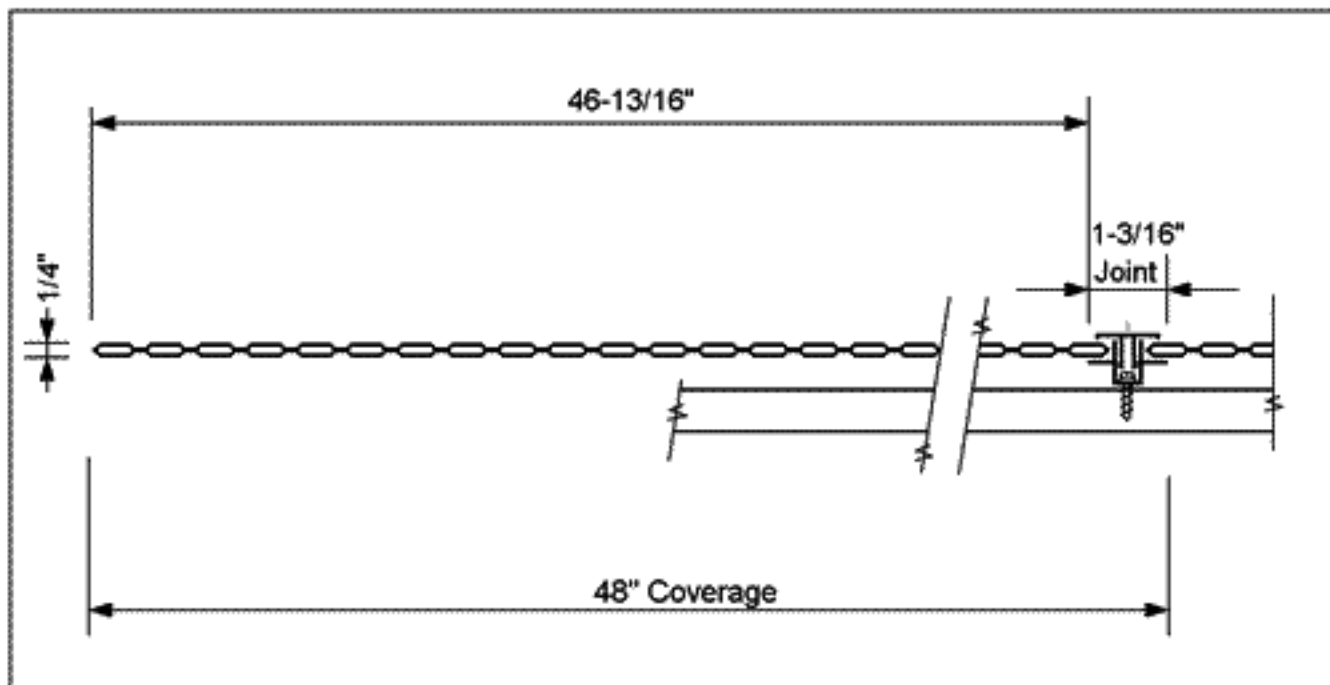

## Panel Data

MODEL NO.	THICK.	METAL	#/SF
<input type="checkbox"/> RPQTL32A	0.032"	Aluminum	0.51#
<input type="checkbox"/> RPQTL40A	0.040"	Aluminum	0.62#
<input type="checkbox"/> RPQTL50A	0.050"	Aluminum	0.77#
<input type="checkbox"/> RPQTL63A	0.063"	Aluminum	0.96#
<input type="checkbox"/> RPQTL80A	0.080"	Aluminum	1.19#
<input type="checkbox"/> RPQTL18G	26 GA. (.018")	Galvanized	0.86#
<input type="checkbox"/> RPQTL24G	24 GA. (.024")	Galvanized	1.15#
<input type="checkbox"/> RPQTL30G	22 GA. (.030")	Galvanized	1.44#

## Technical

**FINISH:** Standard are White (F41), Baron Ivory (F105), and Victorian Gray (F307)  
 Custom are electro statically applied poly-urethane epoxy paint (F47)  
 Premium are Satin Anodized (F23R), Brushed (F98), and Stainless (F08)  
 Kynar: 32 in stock colors

**FIRE CODE:** Metal is non-combustible (ASTM E-84)

**PERF PATTERN:** 3 Dimensional Slotting, 1/4" thick, providing 40% Open Area, and Being Opaque in Frontal View

**PANEL LENGTH:** Standard length this profile is 12'-0"  
 Other lengths available upon request from 4' to 40'



**AMERICAN DECORATIVE CEILINGS**

(All Rights Reserved) COMP. 11.00

Mail: Post Office Box 605605 - Cleveland, Ohio 44105  
 Packages: 4510 East 71st St. - Cleveland, Ohio 44105  
 Telephone: (216) 341-2222  
 FAX: (216) 341-8501