

CURVILINEAR

Photo



Technical

UNIT SIZES: Standard is 4" wide x 120" long. Custom sizes available.

FINISHES: Standards are Mastic White (#F41M), Anodized PXL (F23), or GunMetal (F253). Custom painted are polyurethane epoxy (#F47). Mirrored/Brushed are polished brite (#FSP). Wood Laminates are (#F40??)

PERFORATION: Standard Perf's Available.

INSULATION: Standard is 1" thk. black poly bag. Optional is non-woven black fleece.

FIRE CODE: Class 1 Material (ASTM E84)

MATERIAL: Adequate thickness Aluminum Leads - 70% Recycled Content

(Contact Factory for full Architectural Specification)

MLR - Round Edge

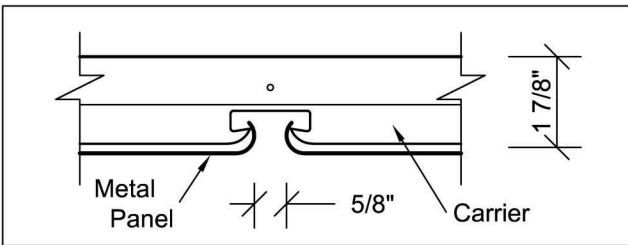

MLS - Square Edge

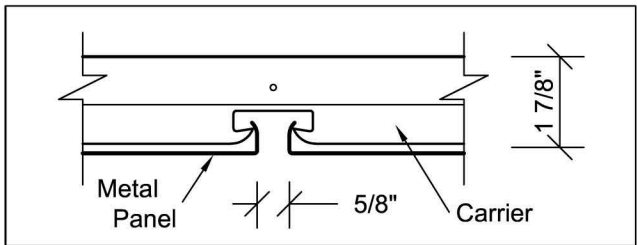

Installation

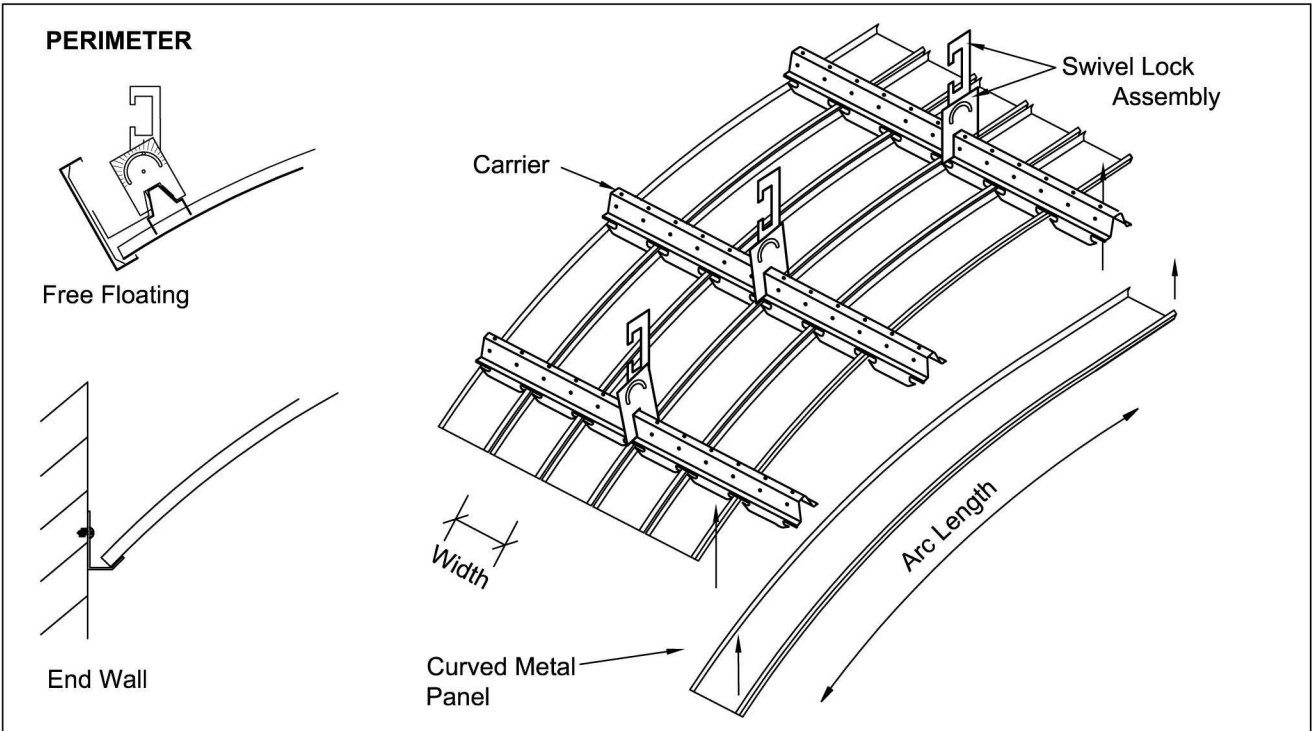

CURVILINEAR PERFORATIONS

STANDARD PATTERN P44 (.063 x .216 staggered)

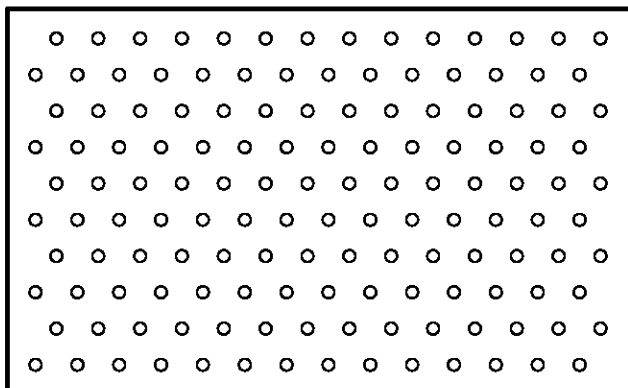

DIM 'X'	DIM 'Y'	ANGLE	OPEN AREA	BORDER
0.216"	0.188"	60~	7%	NO

SPECIAL PATTERN P55 (.078 x .270 staggered)

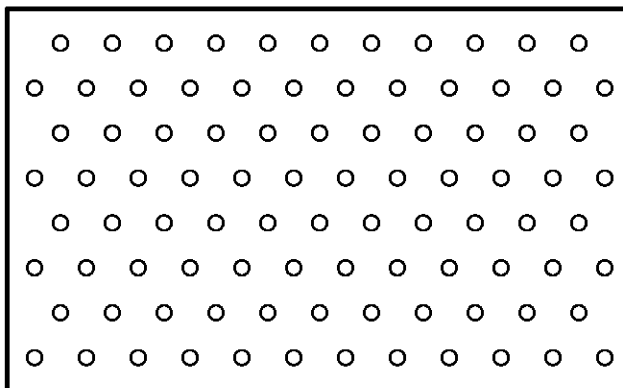

DIM 'X'	DIM 'Y'	ANGLE	OPEN AREA	BORDER
0.270"	0.234"	60~	8%	YES

SPECIAL PATTERN P64 (.094 x .250 staggered)

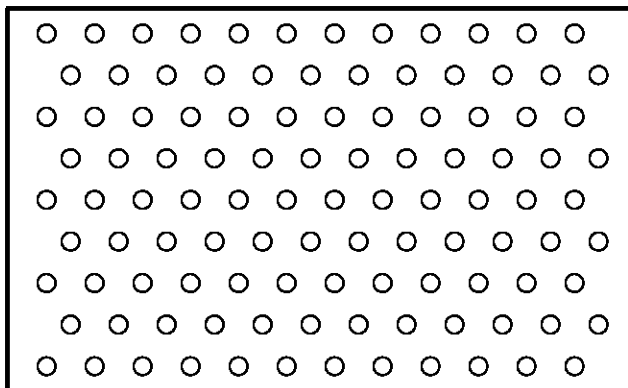

DIM 'X'	DIM 'Y'	ANGLE	OPEN AREA	BORDER
0.250	0.217	60~	13%	NO

SPECIAL PATTERN P65 (.094 x .328 staggered)

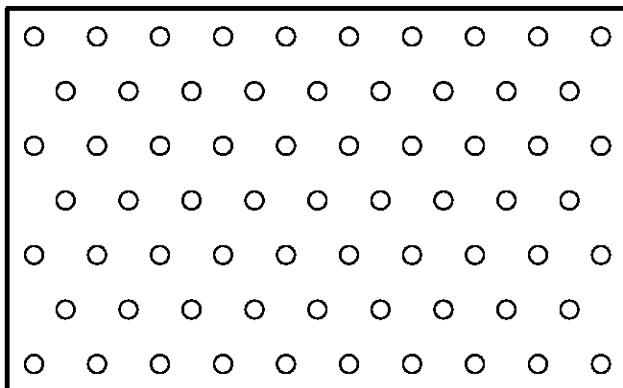

DIM 'X'	DIM 'Y'	ANGLE	OPEN AREA	BORDER
0.328	0.284	60~	8%	NO

SPECIAL PATTERN P66 (.094 x .433 staggered)

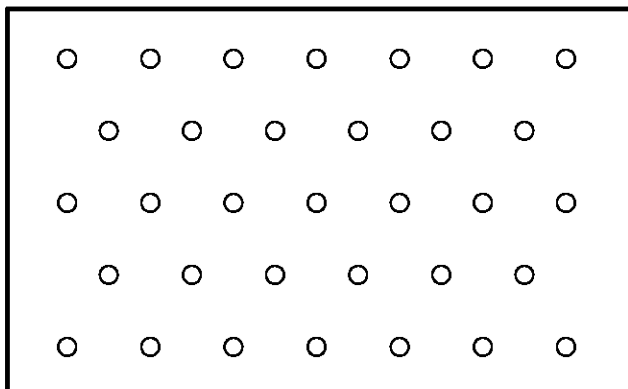

DIM 'X'	DIM 'Y'	ANGLE	OPEN AREA	BORDER
0.433	0.375	60~	5%	NO

SPECIAL PATTERN P88 (.125 x .328 staggered)

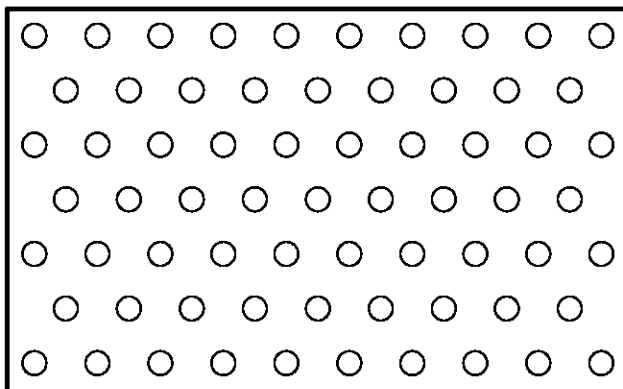

DIM 'X'	DIM 'Y'	ANGLE	OPEN AREA	BORDER
0.328	0.284	60~	14%	NO

Note: Other Perforation Patterns Available at a Slight Upcharge. Contact Factory with Particulars.



AMERICAN DECORATIVE CEILINGS
(ALL RIGHTS RESERVED) STD-LP.DWG

Mail: Post Office Box 605605 - Cleveland, Ohio 44105
 Packages: 4510 East 71st St. - Cleveland, Ohio 44105
 Telephone: (216) 341-2222 - Fax (800) 336-8501
 email: info@amer-dec.com