

WOOD VISIONS 100R

Introduction

WOOD VISIONS 100R provides an intriguing combination of the richness of wood with the ease of torsion spring panel installation. The various reveal widths allow for panel accentuation.

Technical

Panel Sizes:

Standard is 2' x 2'

Optional are 1' x 1' to 3-1/2' x 10'

Standard Reveals:

R0 = 0"; R1 = 1/8"; R2 = 1/4"; or R3 = 3/8"

FINISHES

Standard are mfg's Premo Wood Laminate

Premium are mfg's Re-al Wood Veneer

PLENUM:

12" Recommended Minimum

FIRE CODE:

Class 1 Material; per ASTM E84

Fire rated suspension available.

MATERIAL:

.040" Thick Aluminum (Minimum) & Laminate,

.024" Thick Galvanized (Minimum) & Laminate

Photo

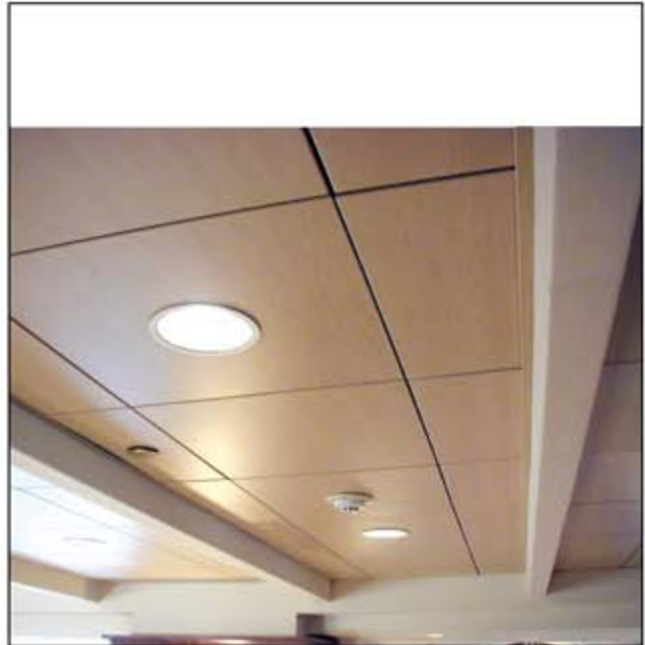

Installation

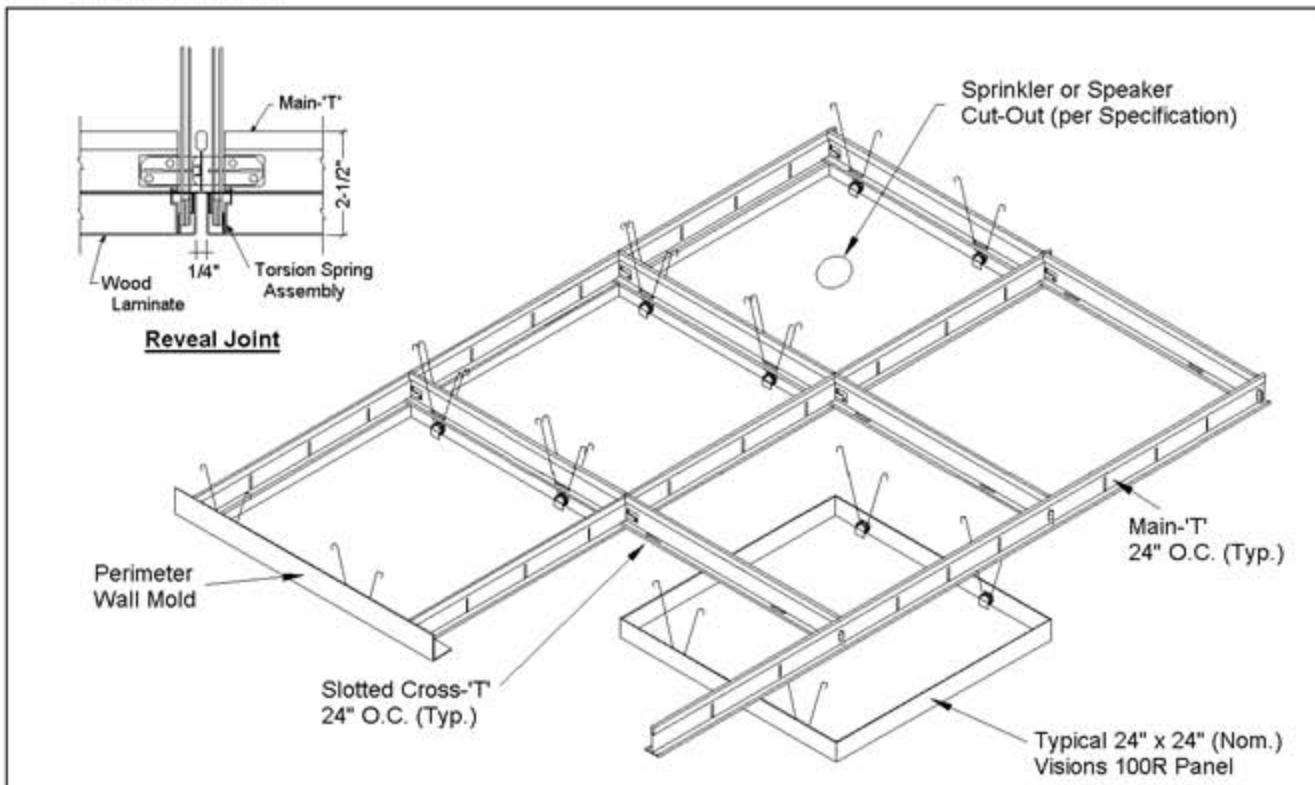

AMERICAN DECORATIVE CEILINGS

(All Rights Reserved)

Mail: Post Office Box 605605 - Cleveland, Ohio 44105

Packages: 4510 East 71st St. - Cleveland, Ohio 44105

Telephone: (216) 341-2222

FAX: (216) 341-8501

M-2W

VISIONS STD. PERFS

PATTERN P42 (1/16" x 7/32" straight)

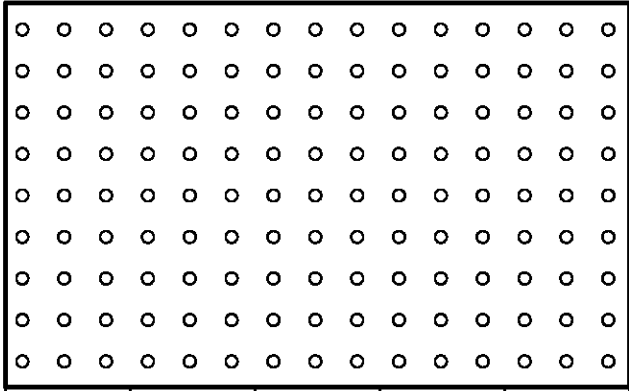

DIM 'X'	DIM 'Y'	ANGLE	OPEN AREA	BORDER
0.216"	0.188"	90~	7%	YES

PATTERN P44 (1/16" x 7/32" staggered)

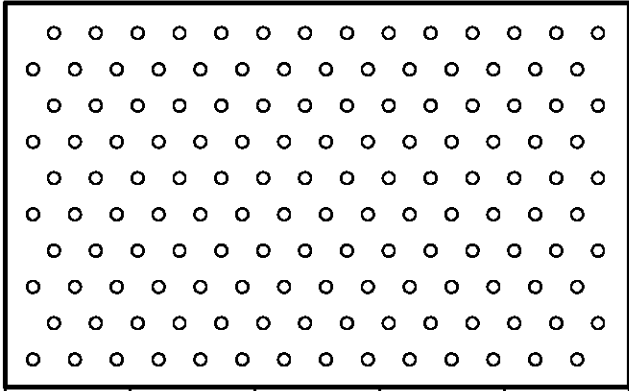

DIM 'X'	DIM 'Y'	ANGLE	OPEN AREA	BORDER
0.216"	0.188"	60~	7%	NO

PATTERN P65 (3/32" x 21/64" staggered)

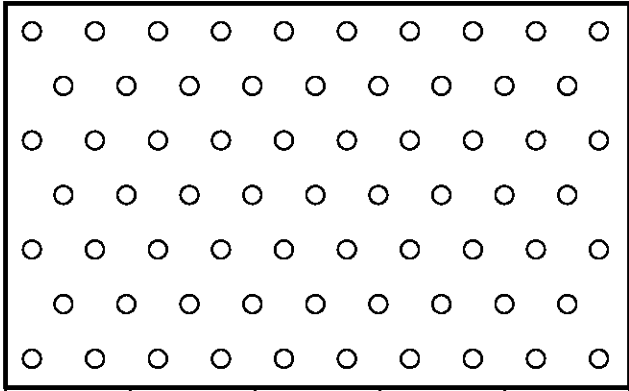

DIM 'X'	DIM 'Y'	ANGLE	OPEN AREA	BORDER
0.328	0.284	60~	8%	NO

PATTERN P66 (3/32" x 7/16" staggered)

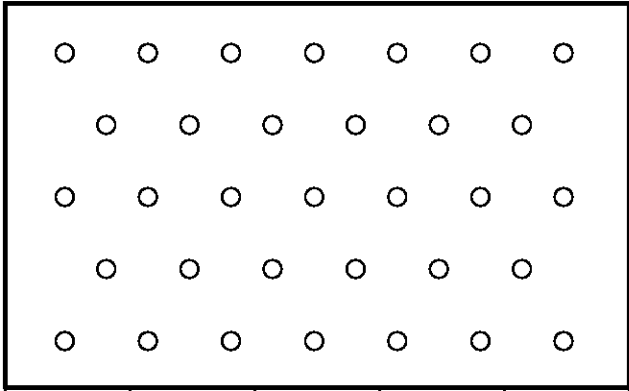

DIM 'X'	DIM 'Y'	ANGLE	OPEN AREA	BORDER
0.433	0.375	60~	5%	NO

PATTERN P81 (1/8" x 1/4" straight)

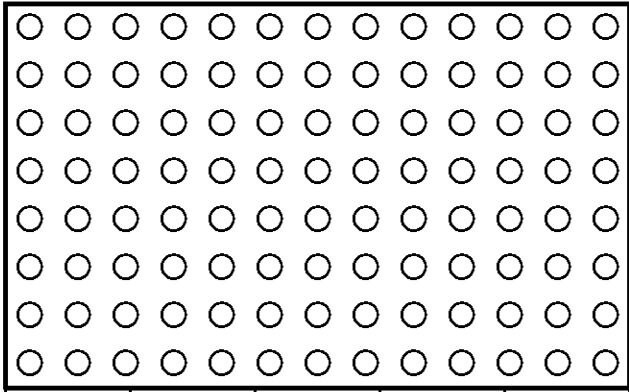

DIM 'X'	DIM 'Y'	ANGLE	OPEN AREA	BORDER
0.250	0.250	90~	20%	AVAIL.

PATTERN P82 (1/8" x 1/2" straight)

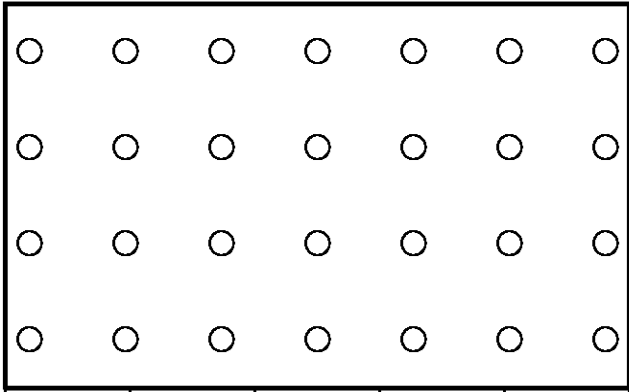

DIM 'X'	DIM 'Y'	ANGLE	OPEN AREA	BORDER
0.500	0.500	90~	5%	AVAIL.

Note: Other Perforation Patterns Available at a Slight Upcharge. Contact Factory with Particulars.



VISIONS STND. PERFS

PATTERN P85 (1/8" x 3/8" staggered)

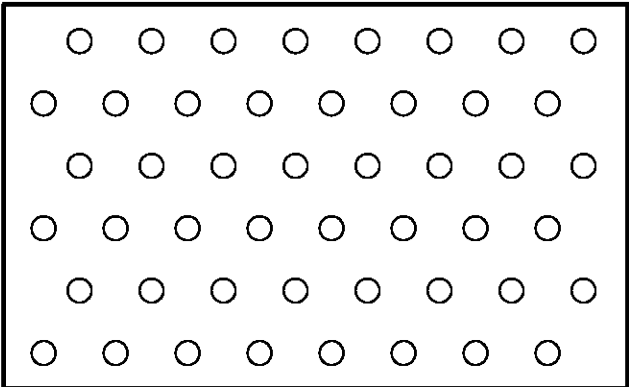

DIM 'X'	DIM 'Y'	ANGLE	OPEN AREA	BORDER NO
0.375	0.326	60~	10%	NO

PATTERN P123 (3/16" x 3/8" straight)

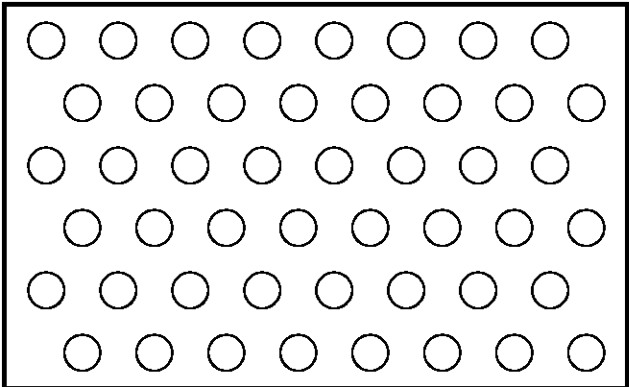

DIM 'X'	DIM 'Y'	ANGLE	OPEN AREA	BORDER NO
0.375	0.325	60~	23%	NO

PATTERN P124 (3/16" x 7/16" straight)

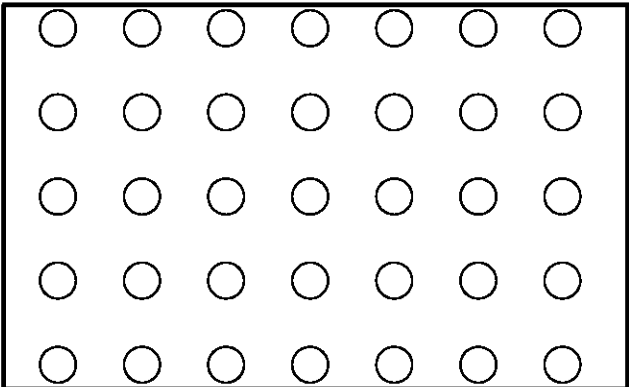

DIM 'X'	DIM 'Y'	ANGLE	OPEN AREA	BORDER AVAIL.
0.438	0.438	90~	15%	AVAIL.

PATTERN P127 (3/16" x 1" staggered)

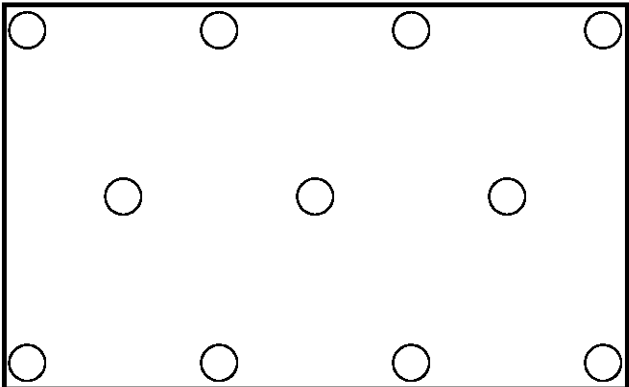

DIM 'X'	DIM 'Y'	ANGLE	OPEN AREA	BORDER NO
1.000	0.866	60~	3%	NO

PATTERN P16S1 (1/4" Sq. x 3/4" staight)

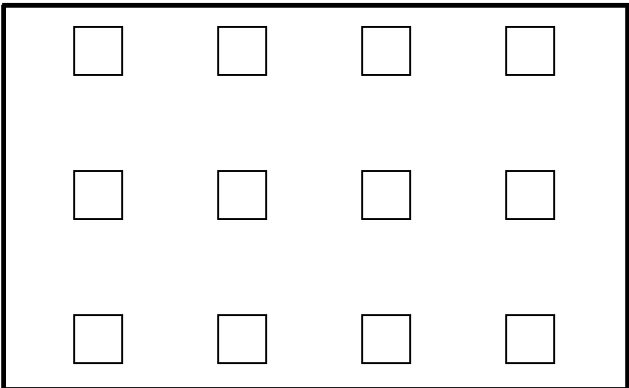

DIM 'X'	DIM 'Y'	ANGLE	OPEN AREA	BORDER AVAIL.
0.750	0.750	90~	11%	AVAIL.

PATTERN P163 (1/4" x 11/32" staggered)

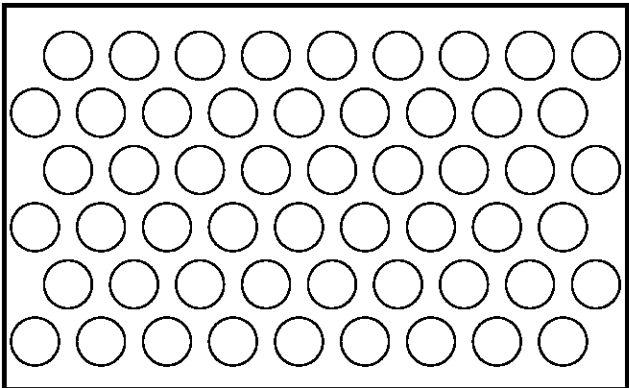

DIM 'X'	DIM 'Y'	ANGLE	OPEN AREA	BORDER NO
0.343	0.297	60~	48%	NO

Note: Other Perforation Patterns Available at a Slight Upcharge. Contact Factory with Particulars.

