

VISIONS 900

Introduction

Visions 900 is an accessible, ship-lap, metal pan ceiling system. Its concealed suspension provides an unincumbered, smooth, monolithic look. Acoustical and aesthetic perforations are available.

Technical

PANEL SIZES:
 Standard is 2' x 2'
 Optional are 1' x 1' to 3' x 10'

FINISHES:
 Standard are mfg's baked polyester (FSTD)
 Custom are polyurethane epoxy (#F47)
 Mirrored is polished chrome (#F03)

PLENUM:
 4" Recommended w/o HVAC or lights.
 12" Recommended w/HVAC or lights

FIRE CODE:
 Class A Material; non-combustible (fire-rated and/or seismic rated t-bar grid avail. upon request)

MATERIAL:
 T-bar Grid; galvanized steel, int. and heavy duty avail.
 0.025" thk. aluminum/steel (Std. Duty)
 0.032" thk. aluminum/steel (Intermediate Duty)
 0.040" thk. aluminum/steel (Heavy Duty)

Suspension Detail

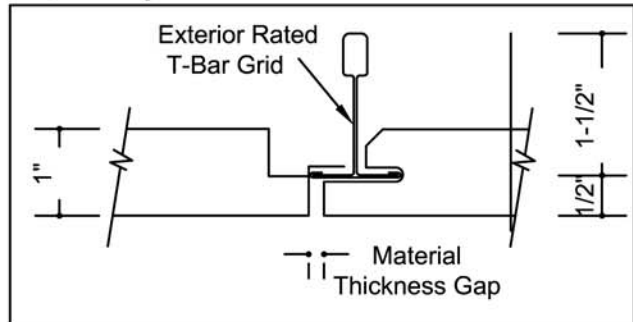

VS9 Data

MODEL NUMBER	MATERIAL	THICKNESS	WEIGHT PER SF
VS918/22-F41	E.P.Steel	0.018"	1.2#
VS924/22-F41	E.P.Steel	0.024"	1.5#
VS930/22-F41	E.P.Steel	0.030"	1.7#
VS925/22-F41	Aluminum	0.025"	.6#
VS932/22-F41	Aluminum	0.032"	0.8"
VS940/22-F41	Aluminum	0.040"	1.0#

Installation

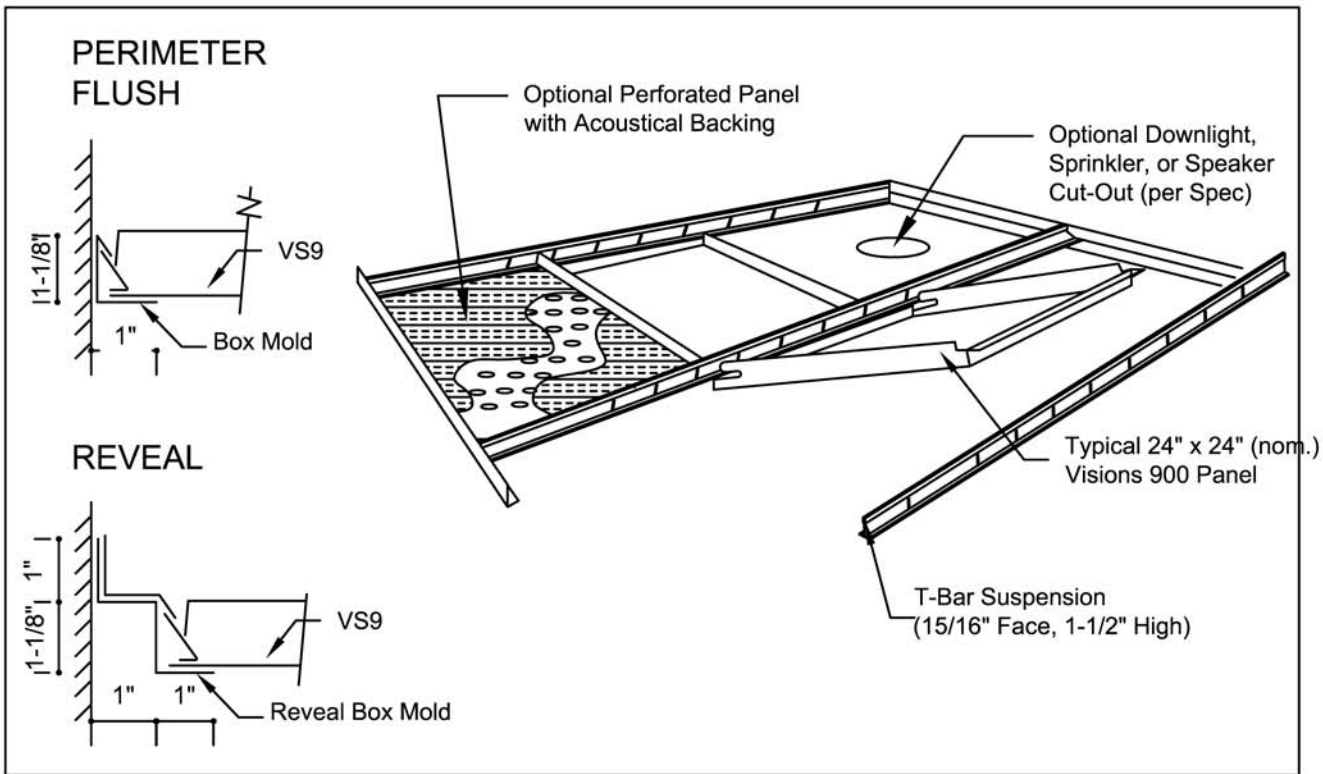

VISIONS STD. PERFS

PATTERN P42 (1/16" x 7/32" straight)

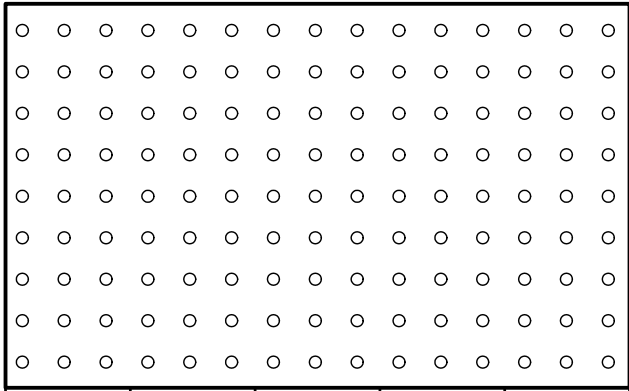

DIM 'X'	DIM 'Y'	ANGLE	OPEN AREA	BORDER
0.216"	0.188"	90~	7%	YES

PATTERN P44 (1/16" x 7/32" staggered)

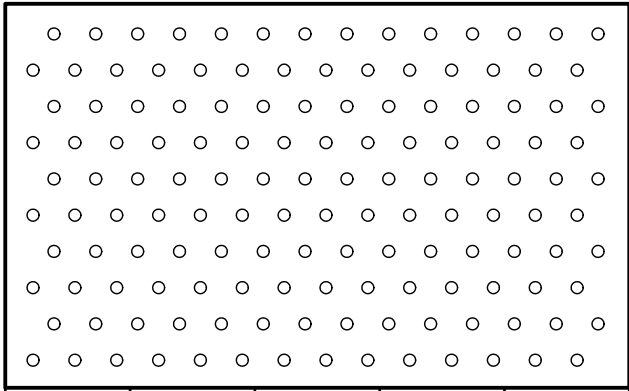

DIM 'X'	DIM 'Y'	ANGLE	OPEN AREA	BORDER
0.216"	0.188"	60~	7%	NO

PATTERN P65 (3/32" x 21/64" staggered)

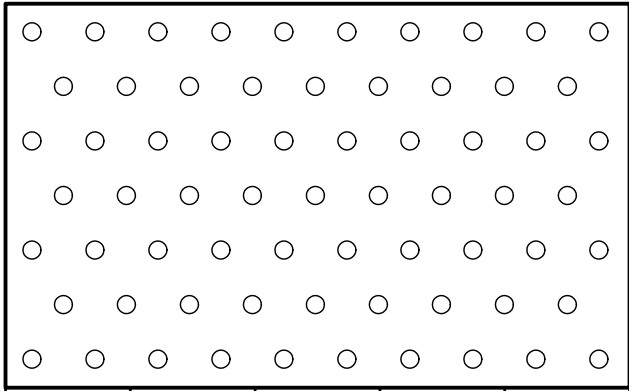

DIM 'X'	DIM 'Y'	ANGLE	OPEN AREA	BORDER
0.328	0.284	60~	8%	NO

PATTERN P66 (3/32" x 7/16" staggered)

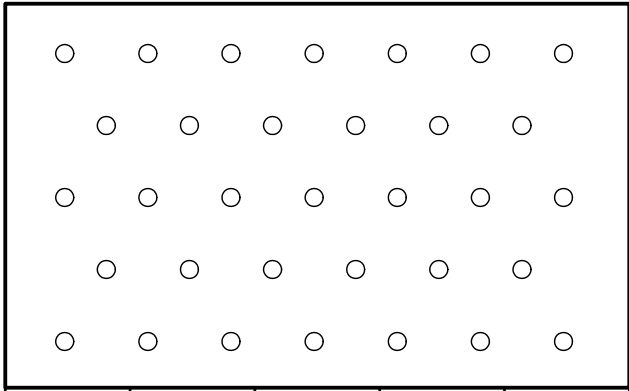

DIM 'X'	DIM 'Y'	ANGLE	OPEN AREA	BORDER
0.433	0.375	60~	5%	NO

PATTERN P81 (1/8" x 1/4" straight)

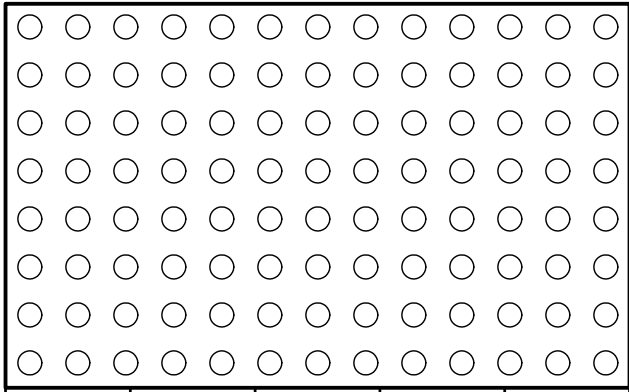

DIM 'X'	DIM 'Y'	ANGLE	OPEN AREA	BORDER
0.250	0.250	90~	20%	AVAIL.

PATTERN P82 (1/8" x 1/2" straight)

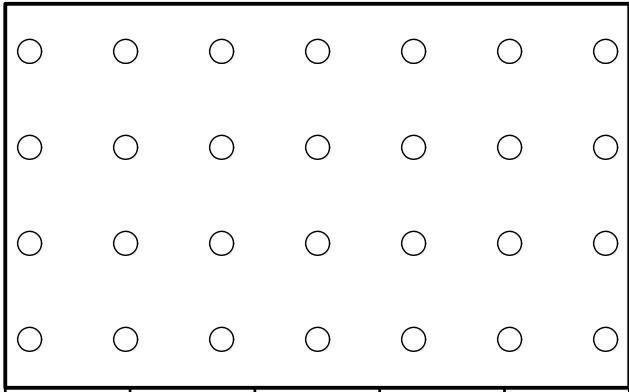

DIM 'X'	DIM 'Y'	ANGLE	OPEN AREA	BORDER
0.500	0.500	90~	5%	AVAIL.

Note: Other Perforation Patterns Available at a Slight Upcharge. Contact Factory with Particulars.



VISIONS STND. PERFS

PATTERN P85 (1/8" x 3/8" staggered)

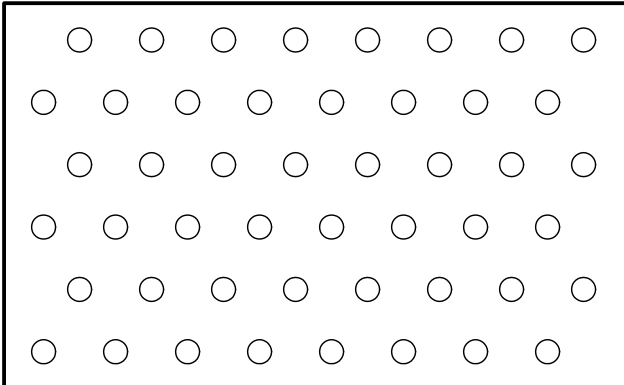

DIM 'X'	DIM 'Y'	ANGLE	OPEN AREA	BORDER NO
0.375	0.326	60~	10%	NO

PATTERN P123 (3/16" x 3/8" straight)

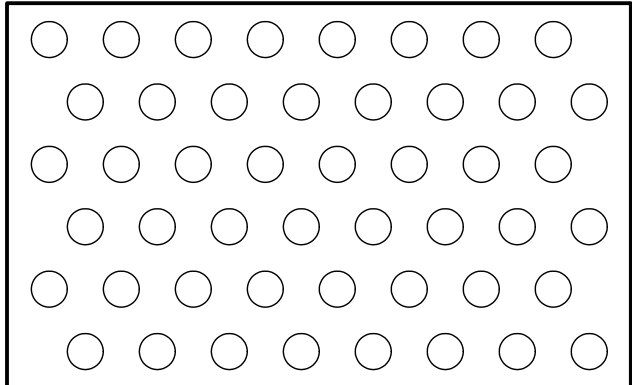

DIM 'X'	DIM 'Y'	ANGLE	OPEN AREA	BORDER NO
0.375	0.325	60~	23%	NO

PATTERN P124 (3/16" x 7/16" straight)

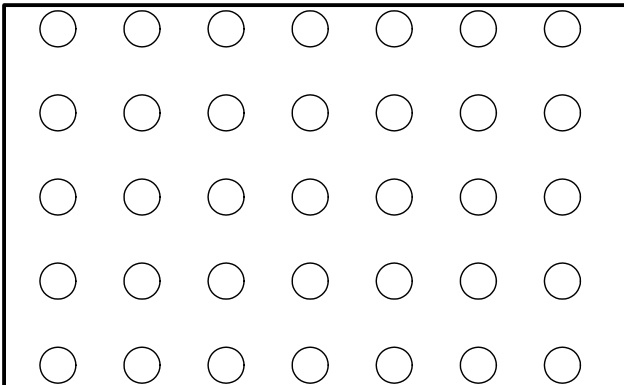

DIM 'X'	DIM 'Y'	ANGLE	OPEN AREA	BORDER AVAIL.
0.438	0.438	90~	15%	AVAIL.

PATTERN P127 (3/16" x 1" staggered)

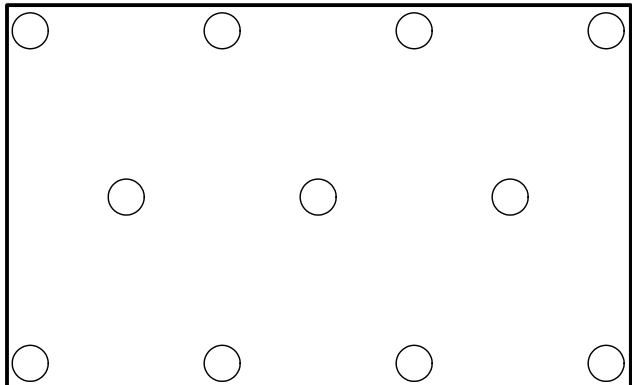

DIM 'X'	DIM 'Y'	ANGLE	OPEN AREA	BORDER NO
1.000	0.866	60~	3%	NO

PATTERN P16S1 (1/4" Sq. x 3/4" staight)

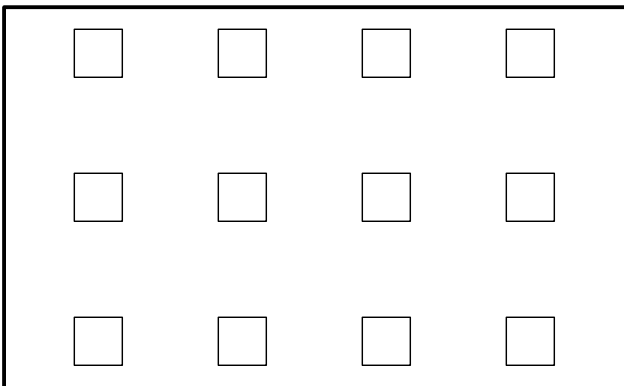

DIM 'X'	DIM 'Y'	ANGLE	OPEN AREA	BORDER AVAIL.
0.750	0.750	90~	11%	AVAIL.

PATTERN P163 (1/4" x 11/32" staggered)

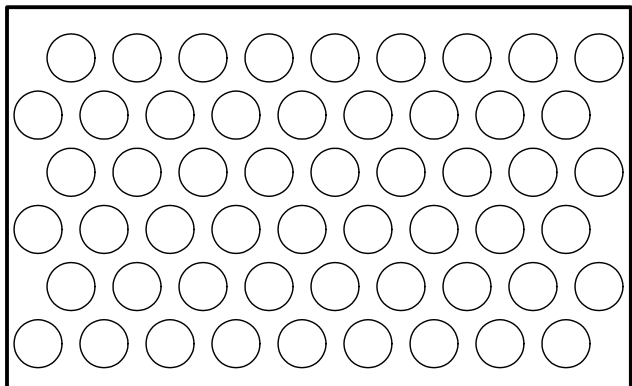

DIM 'X'	DIM 'Y'	ANGLE	OPEN AREA	BORDER NO
0.343	0.297	60~	48%	NO

Note: Other Perforation Patterns Available at a Slight Upcharge. Contact Factory with Particulars.

