

VISIONS 500

Introduction

VISIONS 500 is a 3-Dimensional snap-in metal ceiling system.

1. For standard available perforation pattern see page MP-1
2. For complete Architectural Specification, contact factory.

Technical

MODULES:
Standard is 2'x2'
optional are 1'x1'. 2 1/2'x8"

FINISHES:
Standard are polyester roll coated. (#FSTD)
Custom painted are polyurethane epoxy. (#F47)
Mirrored are polished brite. (#F08-silver) (#F07-Gold)

PLENUM:
4" recommended w/o HVAC or lights
12" recommended w/HVAC or additional lights

FIRE CODE:
Non-combustible, fire rated grid available

MATERIAL:
0.020" thick aluminum/steel (interior)
0.025" thick aluminum/steel (exterior)

Photo

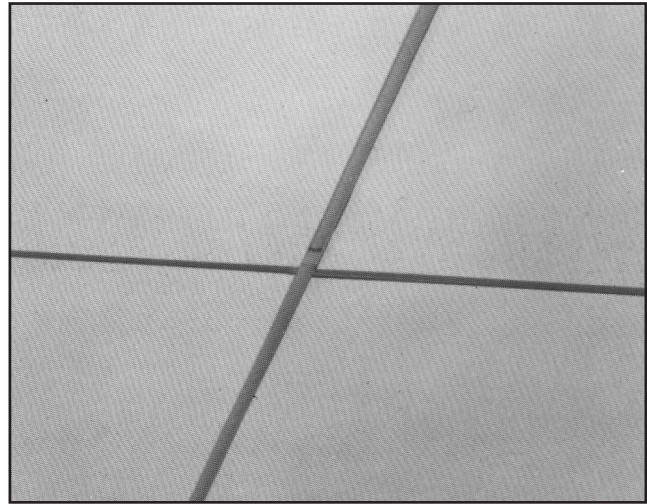

VS2 Data

MODEL NUMBER	MATERIAL	THICKNESS	WEIGHT PER SF
VS518S/22-F??	Steel	0.018"	1.0#
VS524S/22-F??	Steel	0.018"	1.3#
VS520A/22-F??	Aluminum	0.020"	0.4#
VS525A/22-F??	Aluminum	0.025"	0.6#
VS532A/22-F??	Aluminum	0.032"	0.8#

Installation

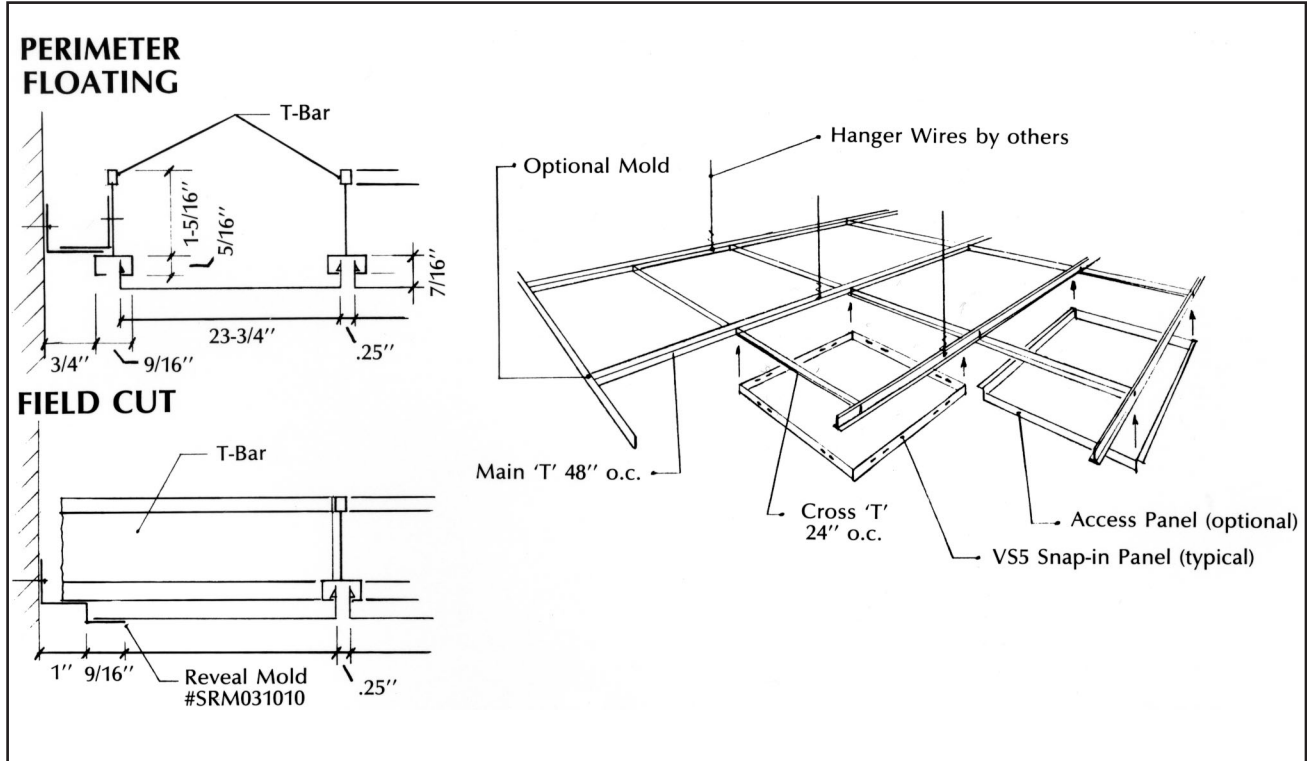

VISIONS STD. PERFS

PATTERN P42 (1/16" x 7/32" straight)

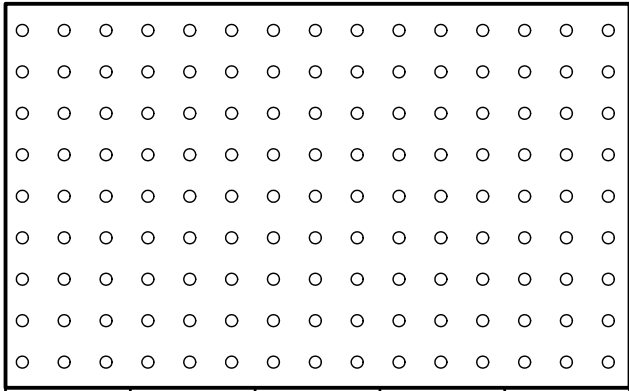

DIM 'X'	DIM 'Y'	ANGLE	OPEN AREA	BORDER
0.216"	0.188"	90~	7%	YES

PATTERN P44 (1/16" x 7/32" staggered)

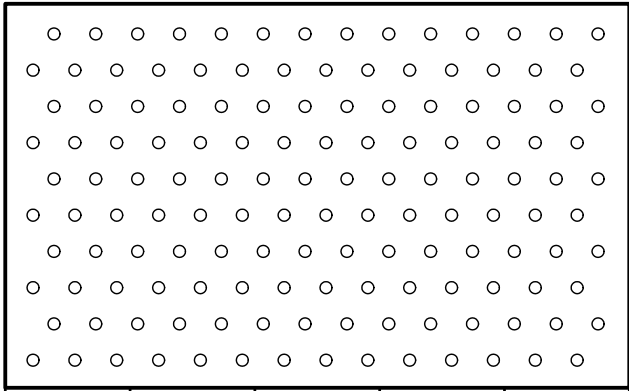

DIM 'X'	DIM 'Y'	ANGLE	OPEN AREA	BORDER
0.216"	0.188"	60~	7%	NO

PATTERN P65 (3/32" x 21/64" staggered)

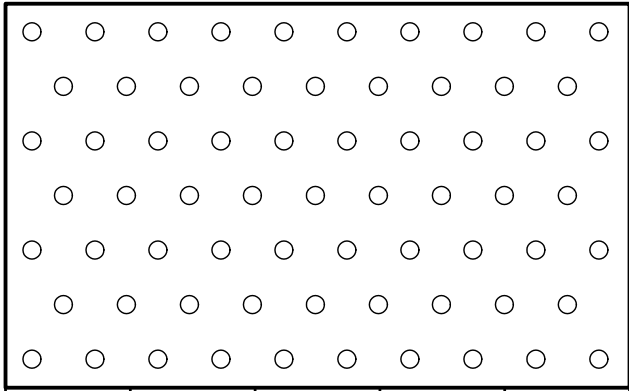

DIM 'X'	DIM 'Y'	ANGLE	OPEN AREA	BORDER
0.328	0.284	60~	8%	NO

PATTERN P66 (3/32" x 7/16" staggered)

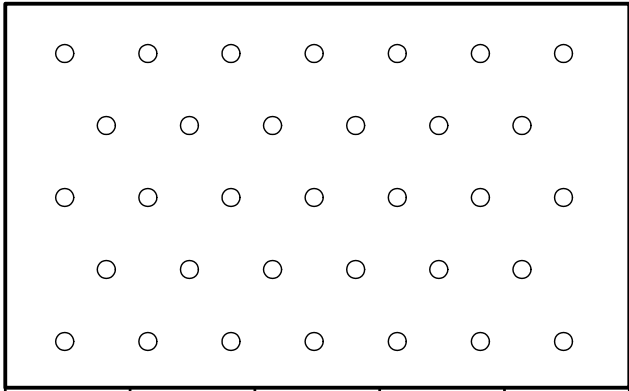

DIM 'X'	DIM 'Y'	ANGLE	OPEN AREA	BORDER
0.433	0.375	60~	5%	NO

PATTERN P81 (1/8" x 1/4" straight)

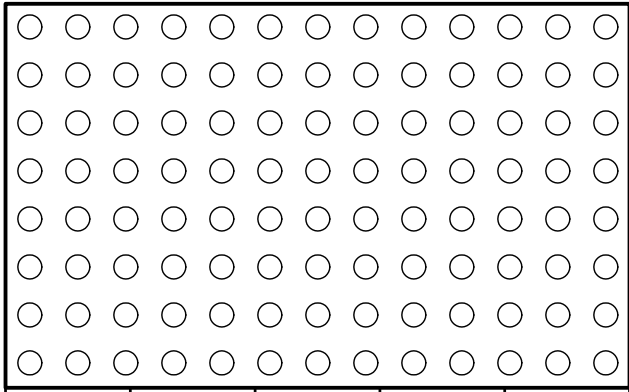

DIM 'X'	DIM 'Y'	ANGLE	OPEN AREA	BORDER
0.250	0.250	90~	20%	AVAIL.

PATTERN P82 (1/8" x 1/2" straight)

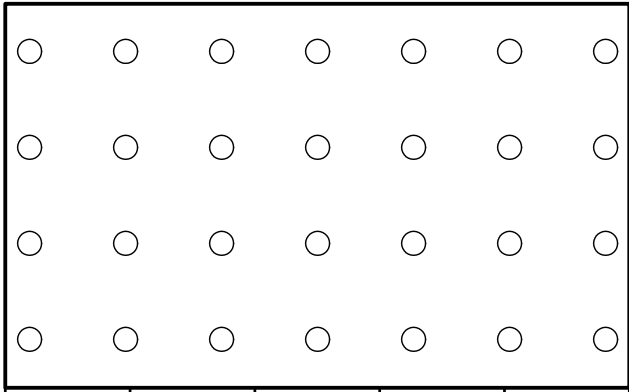

DIM 'X'	DIM 'Y'	ANGLE	OPEN AREA	BORDER
0.500	0.500	90~	5%	AVAIL.

Note: Other Perforation Patterns Available at a Slight Upcharge. Contact Factory with Particulars.



VISIONS STND. PERFS

PATTERN P85 (1/8" x 3/8" staggered)

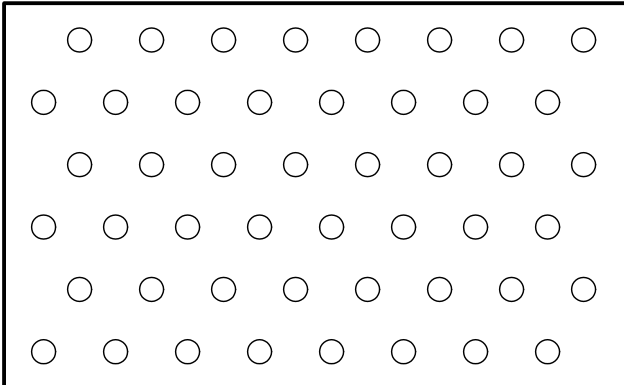

DIM 'X'	DIM 'Y'	ANGLE	OPEN AREA	BORDER NO
0.375	0.326	60~	10%	NO

PATTERN P123 (3/16" x 3/8" straight)

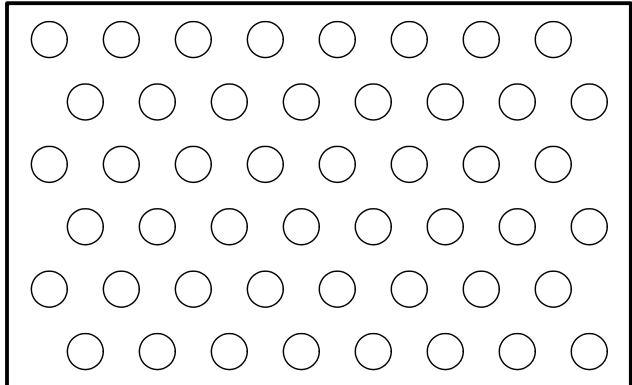

DIM 'X'	DIM 'Y'	ANGLE	OPEN AREA	BORDER NO
0.375	0.325	60~	23%	NO

PATTERN P124 (3/16" x 7/16" straight)

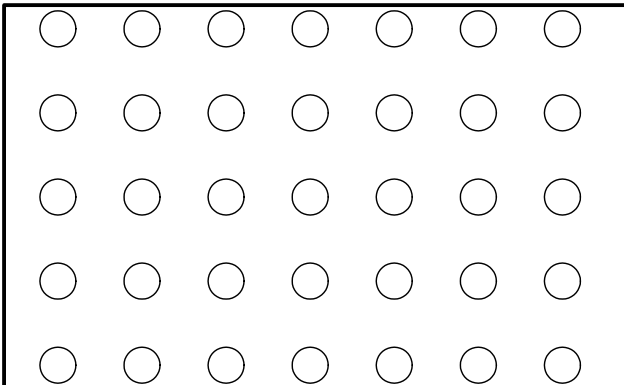

DIM 'X'	DIM 'Y'	ANGLE	OPEN AREA	BORDER AVAIL.
0.438	0.438	90~	15%	AVAIL.

PATTERN P127 (3/16" x 1" staggered)

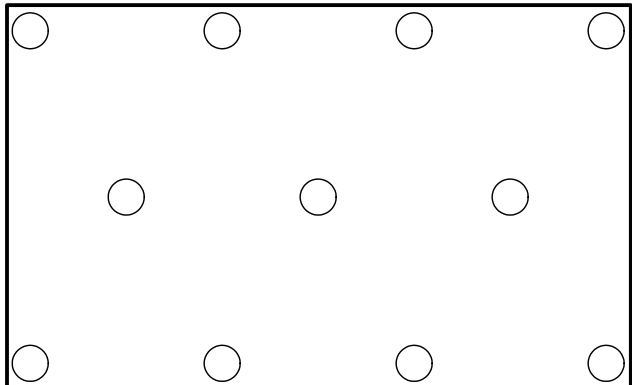

DIM 'X'	DIM 'Y'	ANGLE	OPEN AREA	BORDER NO
1.000	0.866	60~	3%	NO

PATTERN P16S1 (1/4" Sq. x 3/4" staight)

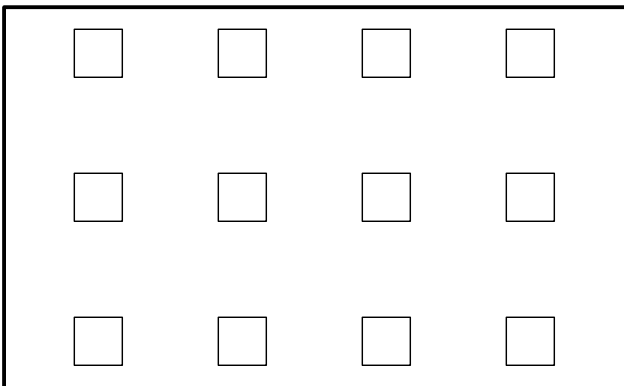

DIM 'X'	DIM 'Y'	ANGLE	OPEN AREA	BORDER AVAIL.
0.750	0.750	90~	11%	AVAIL.

PATTERN P163 (1/4" x 11/32" staggered)

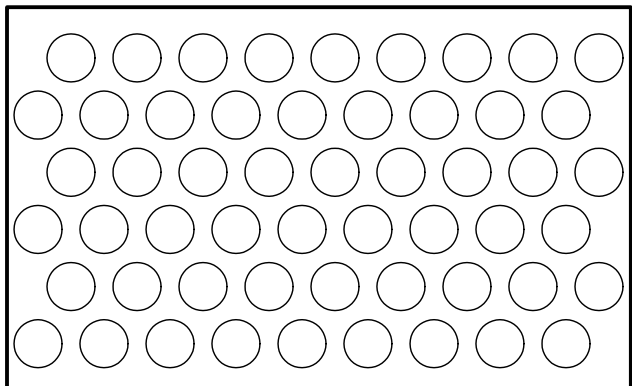

DIM 'X'	DIM 'Y'	ANGLE	OPEN AREA	BORDER NO
0.343	0.297	60~	48%	NO

Note: Other Perforation Patterns Available at a Slight Upcharge. Contact Factory with Particulars.

